

**ESCAPE FITNESS.**

YOUR ESSENTIAL GUIDE TO  
FUNCTIONAL TRAINING.

**ESCAPE  
YOUR  
LIMITS.**

#### CONTRIBUTORS.

##### EDITORIAL.

Matthew Januszek  
and Ritchie Januszek.

##### ART DIRECTION.

Matthew Januszek.

##### DESIGN, PRODUCTION AND PHOTOGRAPHY.

Catherine McCulloch,  
Tony Rogers  
and Elizabeth Morgan.

##### MODELS.

Ashley Moore  
Naomi Bailey  
Andreia Brazier  
Anna Churakova  
Lee Constantinou  
Harry Crook  
Mirella Felicity Ingamells  
Dominic Felix  
Darren Fox  
James Greenwood  
Danni Levy  
Sarita Piotrowski  
Sandra Radav  
Bryn Ray  
Christina Silva  
Max Smith  
Jasmine Takacs  
Lisa Welham  
Karl Wheeler  
Scott Clarke  
Thidadeaw Nophan  
Robert McStay  
Randall Pich  
Ritchie Januszek  
Jessa Sparacino



# ESCAPE FITNESS EST. 1998.

## TWO PASSIONS. ONE ETHOS.

With over 20 years' experience in the fitness industry, Escape Fitness has been at the forefront of functional fitness innovation, product design and rethinking modernized gym layouts to boost engagement and enhance the member experience.

The Escape story began with Richard Januszek, born in the UK just after World War II to Polish parents. An engineer by trade, Richard had a passion for designing products with a simple goal; to make things better.

At 15, Richard's eldest son Matthew, who was inspired by Arnold Schwarzenegger, started to lift weights. To encourage this interest, for Christmas in 1986, Richard converted part of the family garage into a gym.

Ever the innovator, Richard returned from work with a set of shiny stainless-steel bars featuring rotating handles to form what was probably the first dumbbell design to incorporate rotation handles. Following in his father's footsteps, Matthew recycled some old school desks to create a squat stand and bench for the garage gym.

These early ideas and innovations were just the start of what grew to become a hugely successful family business.

Escape Fitness is about partnerships, not meaningless business transactions. It's about building rapport with customers so they become a part of the family, helping shape ideas into a reality through experience, knowledge, innovative equipment, leading programming and expert training.

Two passionate people, one ethos – Escape Fitness - taking the ordinary, and making it extraordinary.

# CONTENTS.



66



46



88

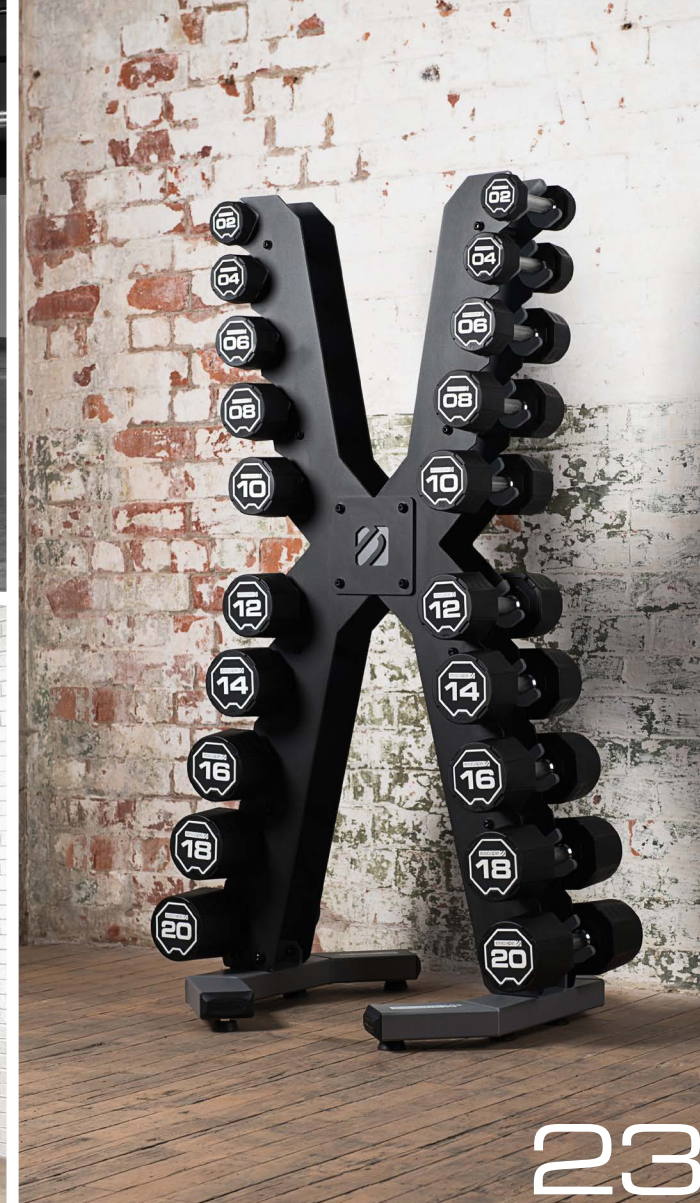

23

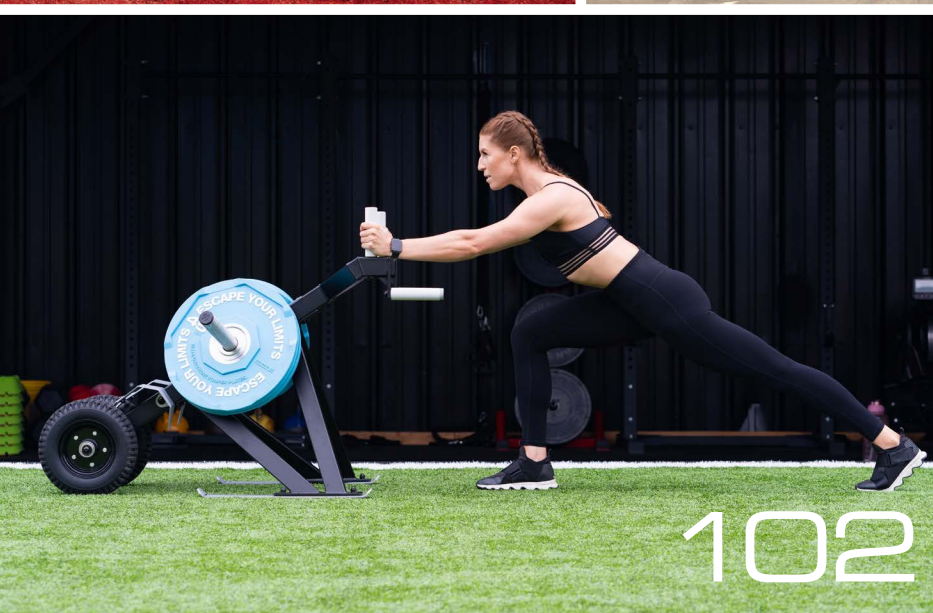

102



12

DIGITAL	06
STRENGTH	10
OCTAGON	52
FUNCTIONAL	100
BOXING	134
FLEXIBILITY	146
FLOORING	160
TRAINING	170
BEFORE YOU ORDER	182
TERMS AND CONDITIONS	184
WARRANTIES	187

# DELIVERING AN OUTSTANDING TRAINING SPACE.

Escape Fitness is a global leader in functional fitness. Through the design of performance-driven training environments, development of innovative equipment, engaging programming and trainer education, Escape pushes the boundaries of what is possible and strives to make the ordinary, extraordinary.



## CONCEPT TO COMPLETION.

Not all functional training spaces are created equal. To future-proof a functional environment requires expertise, knowledge and meticulous execution. Over the years, we have identified 7 key steps to success. These are outlined at the side of this page.

## OUTSTANDING TRAINING SPACES.

Every Escape solution is custom-designed to optimise its space and provide an inspirational experience for both trainers and members. Our team creates functional playgrounds, indoors and outdoors, in dedicated spaces or as an integration into existing facilities.

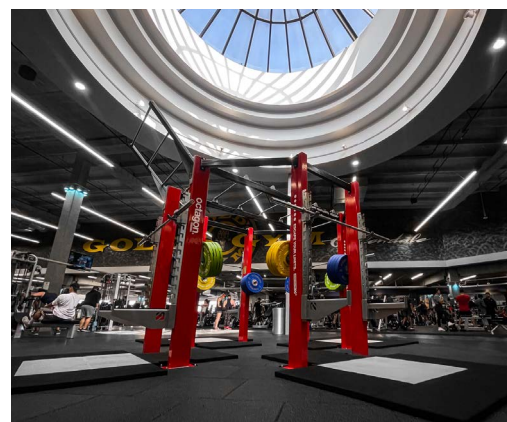

## DRIVING COMMUNITY.

Functional training can bring people together, and this sense of community is what keeps many people exercising. We create the perfect mix using the flexibility of the training style and the adaptability of our equipment to enable all abilities to train together.

## PLANNING YOUR NEW FUNCTIONAL TRAINING SPACE?

Discover how to achieve the launch of an outstanding functional training experience.



SCAN FOR MORE INFORMATION.

## SEVEN STEPS TO SUCCESS IN YOUR SPACE.

### STEP 1.

#### A VISION FOR THE CLUB.

A vision is most of all about understanding your customers. Who do you want to appeal to? What are their fitness and social goals from using a facility? What kind of experience will attract these people? Making firm decisions about your preferred customer profiles and how best to meet their needs enables you to provide unique, personalized experiences.

### STEP 2.

#### EQUIPMENT THAT MEETS YOUR MEMBERS' NEEDS.

With a clear vision in place, it's time to choose suitable equipment. Variety is the key to engaging experiences and functional training equipment delivers, with dozens of options available. But don't become blinded by what's on offer: remain true to your vision and select equipment perfectly suited to your chosen member profiles.

### STEP 3.

#### A BRILLIANT TRAINING ENVIRONMENT.

Boutiques have proven that the environment in which people train is an integral part of the overall experience. It's about great aesthetics – color schemes, lighting, wall graphics and so on – but it doesn't end there. Having a layout that works, suitable flooring and space-efficient equipment racks also contribute.

### STEP 4.

#### KNOWLEDGEABLE, SKILLED AND CONFIDENT TRAINERS.

Functional equipment and free weights do not have on/off switches and they are not always intuitive to use. A club's trainers therefore need the knowledge to help members use the equipment safely and effectively. Add in the confidence to interact with members to form a sense of community and belonging, and you have a recipe for success.

### STEP 5.

#### PROGRAMMING THAT EXCITES MEMBERS.

Most boutiques build their business around their programs, with each one having its own branding to communicate the experience and results members can expect. Without brilliant programming, there's a real danger that members will fail to get on board with functional training. Great programming teaches people how to use the equipment, brings them together for awesome social experiences, and delivers results over the long-term.

### STEP 6.

#### A BUZZ ABOUT WHAT YOU DO.

Once the equipment, environment, trainers and programming are in place, it's time to tell the world. This starts with making sure that all of the club's staff (training and non-training) understand the key points about the equipment and programming. That's the starting point for communicating a clear message and generating word of mouth. Then it's about using online tools to spread the word more widely.

### STEP 7.

#### CONSTANT EVOLUTION TO REMAIN ATTRACTIVE AND COMPETITIVE.

Offering the same experience for months on end can become tiresome and ultimately drive members into the door of a competitor. Boredom should not be an option in any fitness space. This is why regularly reviewing what you're offering is so important, coupled of course with an evolving experience that maintains the excitement and engagement.

# MARS 2.0 WORKOUT SCREEN.

MARS 2.0, the next generation in digital coaching, breaks down barriers to participation for those that feel unsure of how to use functional equipment safely and effectively. Combining first-class education on all our equipment with innovative equipment, MARS 2.0 creates an inclusive virtual coaching environment that everyone can enjoy, on every visit.



## IN-GYM COACHING: THE NEXT GENERATION.

Offer any time access to high quality exercise and equipment instruction.

For training environments where in-person coaching is not always possible such in hotels, residential buildings and corporate gyms, the new Multi Activity Resource Station (MARS 2.0) offers round the clock support, bridging the gap between education and equipment. This helps to create an inclusive environment that everyone can enjoy.

Clicking on the high-definition touchscreen unlocks a huge selection of engaging fitness content from over 580 individual exercises, 25 different pieces of equipment to over 45 full-on workouts. Operators have the option to switch on and switch off content to create a resource library that mirrors the equipment available, delivering a highly bespoke experience for every user.

With content updated monthly MARS 2.0 has the back of every user on every visit, enabling operators to provide a safe, supportive experience regardless of goals or ability.

### SELECT PRODUCT SCREEN.

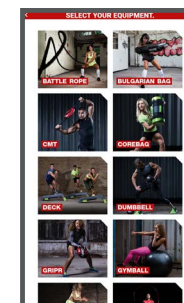

### WORKOUT SCREEN.

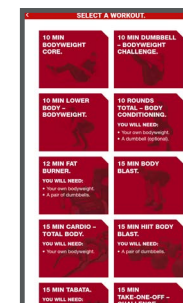

### SELECT LEVEL SCREEN.

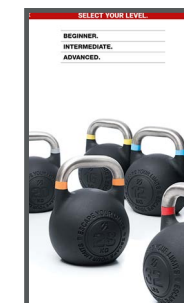

### SELECT EXERCISE SCREEN.

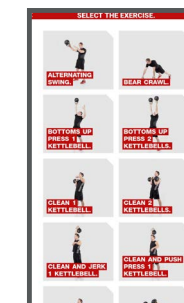

### EXERCISE SCREEN.

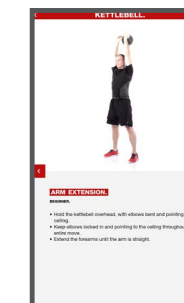

## THREE WAYS TO TRAIN; NO WORKOUT THE SAME.

With multiple options for fitting a MARS screen in your fitness space, both operator and user needs can be met, with expectations exceeded in any gym. Prices start from \$7,500.00.



SCAN FOR MORE INFORMATION.

### 01 MARS ON FRAME.

For the ultimate immersive experience, the MARS screen can be mounted on any Octagon leg around 4.9 feet from the ground or on a beam.



### 02 MARS RACK PACK.

Place the MARS screen between 2 RACK5 units and create a self-contained workout station fully loaded with a selection of Escape functional training equipment.



### 03 SOLO MARS SCREEN.

Bring any wall space to life with the placement of a MARS screen at center stage.



# THE ESCAPE YOUR LIMITS PODCAST.

The Escape Your Limits podcast is a weekly free audio and video release that reveals the mental, physical and emotional ingredients involved in standing out above everybody else.

Every episode enables a hungry audience to discover why successful people keep going when most people stop, and what keeps them going day after day. It's not about shortcuts for dreamers; these people prove that constant hard work Fueled by the right frame of mind is what makes dreams a reality. With Escape Your Limits, we can all learn from specific, actionable experiences and entrepreneurs can share how to make success happen for anyone.



SCAN FOR MORE INFORMATION.

# THE WORKOUT APP.

Now there's support for anyone working out with Escape's functional training equipment – in the gym, outdoors, at work or at home.



SCAN FOR MORE INFORMATION.

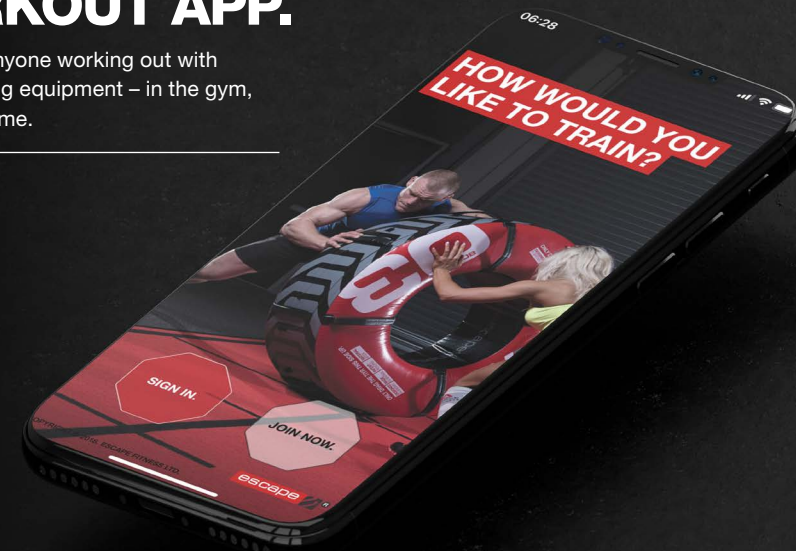

## THE GUESTS.

- DORIAN YATES – EP.75
- LEE HANEY – EP.47
- JIM STOPPANI – EP.65
- BRET CONTRERAS – EP.229
- NICK MITCHELL – EP.122
- KALI MUSCLE – EP.91
- HARLEY PASTERNAK – EP.83
- FRANK ZANE – EP.26, 94 AND 192
- BRET CONTRERAS – EP.90 AND 229
- DR. GABRIELLE LYON – EP.159 AND 252
- JON JON PARK – EP.250
- DR. JOHN JAQUISH – EP.182
- DA RULK – EP.107
- PAUL CHEK – EP.106
- JERRY BRAINUM – EP.264



LISTEN ON ITUNES WATCH ON YOUTUBE

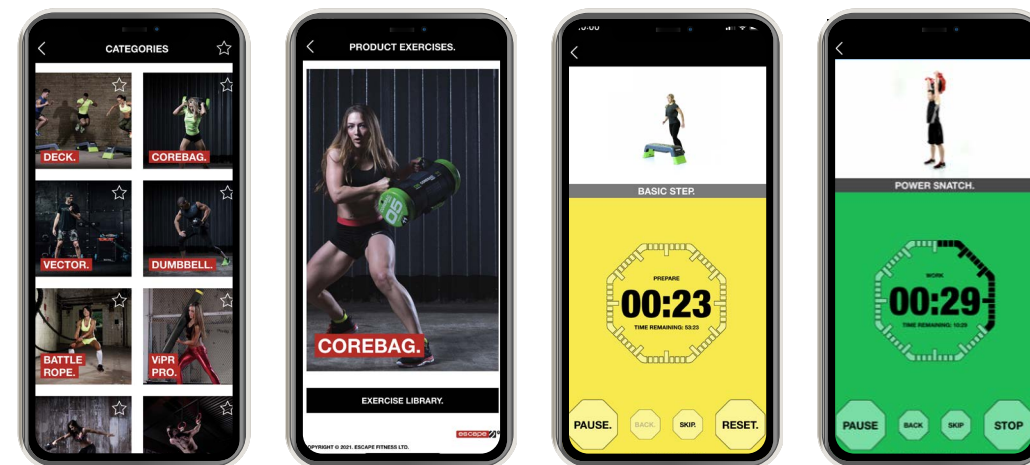

The workout app provides a pocket-sized training partner showcasing the best Escape products, and how to use them, at just the touch of a button.

Discover new ways to exercise using Escape equipment, with a few selected exercises for each item. Follow singles exercises, or take on a full workout to target strength, conditioning or total body benefits.

Available as a free download from the Apple and Android app stores.

### FEATURES.

Exercise content is performed by Escape trainers and feature a wide range of functional tools including Corebags, Sandbags, Multi Grip Medballs, Bulgarian Bags, CMTs, GRIPPRs, Plyosoft Boxes, Kettlebells, Bars and Plates, VERTBALLS, Battle Ropes, STRONGBOX and TIYR are all included.

# STRENGTH.

The strength range stands out from the crowd, with options accessible to all abilities and a durability to withstand the toughest of strength sessions.

Its functionality, considered design and performance sets it apart, and helps your members achieve their goals. With complimentary pieces that complete sets, this range is fit for purpose, durable and practical, seamlessly integrating for a whole strength solution and big lifting experience.



DUMBBELLS	14
STORAGE AND SETS	20
BARBELLS	26
KETTLEBELLS	28
PLATES	36
BARS AND COLLARS	42
LIFT ZONE	45
BENCHES	46



# FREE WEIGHTS - AT THE CORE OF WHAT WE DO.

Functional and strength training has been at the core of our mission and workout philosophy since we embarked on this journey over 25 years ago.

We took a simple resistance training tool, built by my father when I was a teenager, and this became the central idea for our family business start-up, the formation of Escape Fitness and becoming the first company to develop an affordable SBX dumbbell for the UK fitness industry.

Having saved up to import into the UK, we hit our lucky break when a small start-up reached out to us with a problem; they had been let down by their supplier and urgently needed a set of dumbbells for their grand opening the next morning. Presented with the opportunity, we delivered that very same evening.

That small start-up went on to become one of the biggest fitness chains in Europe, and in turn, helped us to become one of the largest suppliers of commercial free weights in the world. Over 1100 tonnes shipped in the last 12 months alone proves that when you invest in an Escape product, you can guarantee your investment is in safe hands.

More than two decades later, we continue to solve problems for our customers and to design and build high quality functional free weight training equipment.

As one of the few fitness companies to own a dedicated manufacturing facility, we produce patented dumbbells and weight plates with complete control of the supply chain, from raw materials to shipping cartons. With no middle men, no trading agents and no additional costs built in, you can be assured you're getting the best possible price and quality on the market.

**Matthew Januszek**



# DUMBBELLS AND BARBELLS.

A pair, or set of dumbbells or barbells is an essential for any fitness goal or training space. To ensure users reap the full benefits of reps and sets, our materials have evolved over years using a special formula and a rigorous testing protocol to ensure we can boast the best on the market, setting a new benchmark for quality. Your investment is manufactured to the highest standards, and seamlessly integrates dumbbells and barbells with our racks and storage solutions, ensuring long-lasting craftsmanship and user satisfaction.



## COMPARISON CHART.

FEATURES.	URETHANE DUMBBELLS.	SBX DUMBBELLS.	STAKRBELL.
USE	Free weight areas for strength training with increased versatility.	Free weight areas for strength training and traditional workouts.	Group Exercise, Studio or Consumer.
HEAD MATERIAL	Urethane	SBX	Cast Iron and Polyurethane
HANDLE	Hard Satin Chrome	Hard Satin Chrome	Ergonomically designed, polyurethane coated
LOCKING	Dual-lock plus	Dual-lock plus	-
WEIGHTS	2.5lb - 30lb (2.5lb increments) 30lb - 150lb (5lb increments)	2.5lb - 25lb (2.5 increments) 5lb - 125lb (5lb increments)	4lb - 6lb (can be stacked up to 20lb)
WARRANTY	5 years	3 years	1 year

## HOW TO CHOOSE.



### URETHANE DUMBBELLS.

Durable to match the demands of high-use facilities, these dumbbells have a permanently-bonded, steelhead and dual lock construction. Featuring weight indications on top and on the sides, the unique head shape, round at the front face to an Octagon at the rear, gives the parallel faces for anti-roll benefits.

### SBX DUMBBELLS.

The SBX dumbbells don't extend as high in weight range but still feature the same patented "Dual Lock Plus" process, hard satin chrome, splined press fit at three tonnes and are full penetration welded. In contrast to the urethane range, the SBX dumbbells cater more for low-to-medium use facilities.



### STAKRBELL.

The STAKRBELL has a unique, flat design for space-saving efficiency, perfect of commercial or at-home use. The stackable weight options create an array of options whilst the non-roll design means these dumbbells will always remain where you place them.



TURN TO PAGE 187 FOR WARRANTIES

STRENGTH.

# URETHANE DUMBBELLS.

With a permanently-bonded, steelhead and dual lock construction, this innovative dumbbell range even features weight indications moulded into top and sides of the weights. Seamlessly integrates with our Rigid or Octagon Rack storage solutions.

**TOP-DOWN NUMBERING.**

Weight indicators visible from your take off and grip positions.

**GRIP.**

Premium textures for squat and swing grip variation.

**HANDLES.**

Salt spray tested chrome handles.

**NUMBERING.**

Oversized numbering for fast weight identification.

**EVOLUTION EDGING.**

Circle-to-octagon shaping inspires anti-roll confidence.



<b>APUDB225</b>	2.5-25lb	Urethane Dumbbell Set 2.5lb incs (10 pairs – 20 total)	<b>\$1,795.00</b>
<b>APUDB550</b>	5-50lb	Urethane Dumbbell Set 5lb incs (10 pairs – 20 total)	<b>\$2,885.00</b>
<b>APUDB575</b>	5-75lb	Urethane Dumbbell Set 5lb incs (15 pairs – 30 total)	<b>\$5,820.00</b>
<b>APUDB55100</b>	55-100lb	Urethane Dumbbell Set 5lb incs (10 pairs, 20 total)	<b>\$6,810.00</b>
<b>APUDB105125</b>	105-125lb	Urethane Dumbbell Set 5lb incs (5 pairs, 10 total)	<b>\$4,825.00</b>
<b>APUDB130150</b>	130-150lb	Urethane Dumbbell Set 5lb incs (5 pairs, 10 total)	<b>\$5,775.00</b>
<b>RACK SPECIFICATIONS.</b>			
<b>RACKDB10</b>	10 Pair Dumbbell Rack (as shown) Holds 10 pairs (up to 50lb pairs) SBX or Urethane Dumbbells (20 total) Size: 77" x 27.5" x 30". Weight 132lb.		<b>\$890.00</b>



# SBX DUMBBELLS.

These SBX dumbbells still feature the same patented "Dual Lock Plus" process, splined press fit at three tonnes and are full penetration welded making them durable and a cost effective alternative to the Urethane range. Also integrates with our Rigid or Octagon Racks and storage solutions.



<b>ARBDB225</b>	2.5-25lb	SBX Dumbbell Set 2.5lb incs (10 pairs – 20 total)	<b>\$1,175.00</b>
<b>ARBDB550</b>	5-50lb	SBX Dumbbell Set 5lb incs (10 pairs – 20 total)	<b>\$2,085.00</b>
<b>ARBDB575</b>	5-75lb	SBX Dumbbell Set 5lb incs (15 pairs – 30 total)	<b>\$4,410.00</b>
<b>ARBDB55100</b>	55-100lb	SBX Dumbbell Set 5lb incs (10 pairs – 20 total)	<b>\$5,440.00</b>
<b>ARBDB105125</b>	105-125lb	SBX Dumbbell Set 5lb incs (5 pairs, 10 total)	<b>\$3,885.00</b>
<b>RACK SPECIFICATIONS.</b>			
<b>RACKDB10</b>	10 Pair Dumbbell Rack (as shown) Holds 10 pairs (up to 50lb pairs) SBX or Urethane Dumbbells (20 total) Size: 77" x 27.5" x 30". Weight 132lb.		<b>\$890.00</b>

STRENGTH.



**NUMBERING.**

Oversized numbering for fast weight identification.

**FIXING.**

Patented fixing technology.

**EVOLUTION EDGING.**

Circle-to-octagon shaping inspires anti-roll confidence.

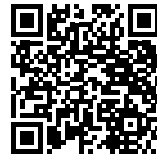

SCAN FOR MORE INFORMATION.

# STAKRBELL.

The STAKRBELL has a unique, flat design for space-saving efficiency, perfect for commercial or at-home use. The stackable weight options create an array of options whilst the non-roll design means these dumbbells will always remain where you place them.

Pair STAKRBELL with either DECK 2.0 or Step Platform Solution to create a complete, independent workout station.

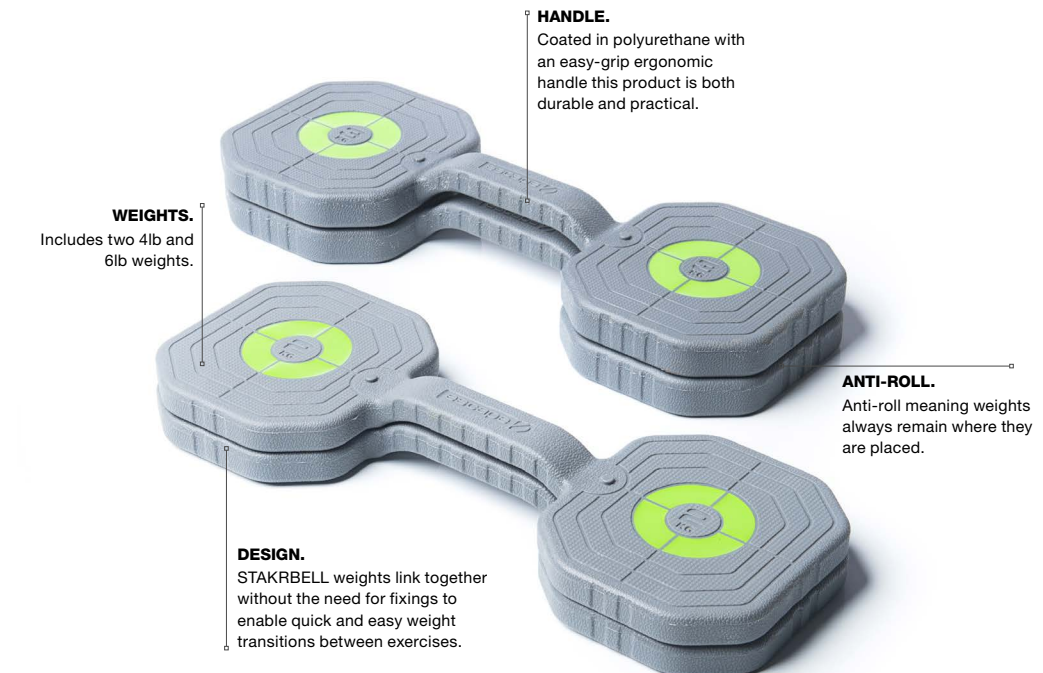

**HANDLE.**  
Coated in polyurethane with an easy-grip ergonomic handle this product is both durable and practical.

**WEIGHTS.**  
Includes two 4lb and 6lb weights.

**ANTI-ROLL.**  
Anti-roll meaning weights always remain where they are placed.

**DESIGN.**  
STAKRBELL weights link together without the need for fixings to enable quick and easy weight transitions between exercises.



**STORAGE.**  
The STAKRBELL is designed to fit inside the integrated storage space in DECK 2.0 to create a space saving solution that keeps training spaces free of clutter.



<b>ASTAKR46</b>	STAKRBELL 4lb and 6lb x2 4lb - 13.9" (L) x 5.05" (D) x 1.04" (H) x2 6lb - 14.4" (L) x 5.3" (D) x 1.3" (H) Total weight per set 20lbs	<b>\$167.00</b>
-----------------	-----------------------------------------------------------------------------------------------------------------------------------------------	-----------------

STRENGTH.

# STORAGE RACKS.

Escape Fitness incorporates two lines of dumbbell storage racks to ensure the right fit, whatever the need. The Rigid Racks are created to provide a slimmer, subtler storage option whereas the Octagon Racks pack more of an aesthetic punch, with a bold, durable design.



## COMPARISON CHART.

FEATURES.	VERTICAL RACK.	XRACK 2.0.	OCTAGON RACKS.	RIGID RACKS.
<b>MATERIAL</b>	Carbon Steel	Carbon Steel	High-grade Steel	Carbon Steel
<b>SIZE</b>	W: 27.5" x D: 27.5" x H: 68"	W: 30" x D: 27.5" x H: 70"	5 Pair Rack W: 53" x D: 15" x H: 30" 10 Pair Rack W: 78" x D: 15" x H: 30" 15 Pair Rack W: 124" x D: 15" x H: 30" 20 Pair Rack W: 124" x D: 15" x H: 30"	10 Pair Rack W: 77" x D: 27.5" x H: 30" 15 Pair Rack W: 77" x D: 27.5" x H: 45"
<b>WEIGHT</b>	73lb	119lb	5 Pair Rack - 108lb 10 Pair Rack - 130lb 15 Pair Rack - 238lb 20 Pair Rack - 260lb	10 Pair Rack - 132lb 15 Pair Rack - 176lb
<b>HOLDS</b>	Holds 20 Dumbbells (10 pairs up to a maximum weight of 50lb).	Holds 20 Dumbbells (10 pairs up to a maximum weight of 50lb).	5 Pair Rack (Holds 5 pairs 10 total) 10 Pair Rack (Holds 10 pairs 20 total) 15 Pair Rack 10 and 5 combined (Holds 15 pairs 30 total) 20 Pair Rack 10 and 10 combined (Holds 20 Pairs 40 total)	10 Pair Rack (Holds 10 pairs 20 total) 15 Pair Rack (Holds 15 pairs 30 total)
<b>WARRANTY</b>	2 Years	5 Years	10 Years	2 Years

# HOW TO CHOOSE.



## VERTICAL RACK.

The Vertical Dumbbell Rack conveniently organizes your Escape dumbbells and delivers a space-saving alternative to a horizontal rack.



## XRACK 2.0.

With a striking look and improved space efficiency, the XRACK adds angular style and practicality to any facility.



## RIGID RACKS.

The Rigid Racks are designed to be a lighter weight, more discreet and slimline rack option to minimize both material and cost.



## OCTAGON RACKS.

Durable, heavy-duty and bold, our Octagon Racks are made in the UK, connect together and complement our Octagon Frames.

STRENGTH.

## DUMBBELL SETS WITH VERTICAL RACK.

Combine your dumbbell set with the Vertical Dumbbell Rack which conveniently organizes your Escape dumbbells and delivers a space-saving alternative to a horizontal rack. Providing easy accessibility, it maximizes floor space with minimal fuss.



<b>URETHANE DUMBBELL SETS WITH VERTICAL RACK.</b>		
<b>APUDB225V</b>	2.5-25lb Urethane Dumbbell Set RACKVDB 2.5lb incs (10 pairs – 20 total)	<b>\$2,480.00</b>
<b>APUDB550V</b>	5-50lb Urethane Dumbbell Set RACKVDB 5lb incs (10 pairs – 20 total)	<b>\$3,570.00</b>
<b>SBX DUMBBELL SETS WITH VERTICAL RACK.</b>		
<b>ARBDB225V</b>	2.5-25lb SBX Dumbbell Set RACKVDB 2.5lb incs (10 pairs – 20 total)	<b>\$1,860.00</b>
<b>ARBDB550V</b>	5-50lb SBX Dumbbell Set RACKVDB 5lb incs (10 pairs – 20 total)	<b>\$2,780.00</b>
<b>RACK SPECIFICATIONS.</b>		
<b>RACKVDB</b>	Vertical Dumbbell Rack (as shown) Holds 20 Dumbbells (10 pairs up to a maximum weight of 50lb). Size: 27.5" x 27.5" x 68". Weight 73lb.	<b>\$700.00</b>

## DUMBBELL SETS WITH XRACK 2.0.

Add angular style and practicality to your dumbbell storage solution by opting to pair your dumbbell set with the bold XRACK 2.0. Maximize vertical storage options with style whilst still making a visual impact.



<b>URETHANE DUMBBELL SETS WITH XRACK 2.0.</b>		
<b>APUDB225X</b>	2.5-25lb Urethane Dumbbell Set XRACK2 2.5lb incs (10 pairs – 20 total)	<b>\$2,915.00</b>
<b>APUDB550X</b>	5-50lb Urethane Dumbbell Set XRACK2 5lb incs (10 pairs – 20 total)	<b>\$4,000.00</b>
<b>SBX DUMBBELL SETS XRACK 2.0.</b>		
<b>ARBDB225X</b>	2.5-25lb SBX Dumbbell Set XRACK2 2.5lb incs (10 pairs – 20 total)	<b>\$2,295.00</b>
<b>ARBDB550X</b>	5-50lb SBX Dumbbell Set XRACK2 5lb incs (10 pairs – 20 total)	<b>\$3,215.00</b>
<b>RACK SPECIFICATIONS.</b>		
<b>XRACK2</b>	XRACK 2.0 (as shown) Holds 20 Dumbbells (10 pairs up to a maximum weight of 50lb). Size: 30" x 27.5" x 70". Weight 119lb.	<b>\$1,140.00</b>

STRENGTH.

## DUMBBELL SETS WITH OCTAGON RACK.

This innovative, low-level storage can be linked together or integrated into a frame. Its smaller footprint takes up less space in the gym, can be fitted closer to a wall and stands underneath your eyeline, keeping visibility for mirrors or wall branding clear.



### URETHANE DUMBBELL SET WITH OCTAGON RACK.

<b>APUDB550L</b>	5-50lb	Urethane Dumbbell Set ULLDB10 5lb incs (10 pairs, 20 total)	<b>\$4,225.00</b>
<b>APUDB575L</b>	5-75lb	Urethane Dumbbell Set ULLDB15 5lb incs (15 pairs, 30 total)	<b>\$8,140.00</b>
<b>APUDB5100L</b>	5-100lb	Urethane Dumbbell Set ULLDB20 5lb incs (20pairs, 40 total)	<b>\$12,130.00</b>

### RACK SPECIFICATIONS.

<b>ULLDB05:</b>	5 Pair Octagon Dumbbell Rack Size: 53" x 15" x 30". Weight 108lb.	<b>\$1,250.00</b>
<b>ULLDB10</b>	10 Pair Octagon Dumbbell Rack Size: 78" x 15" x 30". Weight 130lb.	<b>\$1,370.00</b>
<b>ULLDB15:</b>	15 Pair (ULLDB05 & ULLDB10) Octagon Dumbbell Rack (as shown) Size: 124" x 15" x 30". Weight 238lb.	<b>\$2,350.00</b>
<b>ULLDB20:</b>	20 Pair (ULLDB10 & ULLDB10) Octagon Dumbbell Rack Size: 149" x 15" x 30". Weight 260lb.	<b>\$2,470.00</b>

## DUMBBELL SETS WITH RIGID RACK.

A cost-effective option for keeping members and equipment safe, this storage unit also gives you the ability to turn its feet inwards so that racks can be placed adjacent to each other.



### URETHANE DUMBBELL SETS WITH RIGID RACK.

<b>APUDB550R</b>	5-50lb	Urethane Dumbbell Set RACKDB10 5lb incs (10 pairs – 20 total)	<b>\$3,755.00</b>
<b>APUDB575R</b>	5-75lb	Urethane Dumbbell Set RACKDB15 5lb incs (15 pairs – 30 total)	<b>\$6,970.00</b>
<b>APUDB5100R</b>	5-100lb	Urethane Dumbbell Set RACKDB10/15 5lb incs (20 pairs – 40 total)	<b>\$11,725.00</b>

### SBX DUMBBELL SETS WITH RIGID RACK.

<b>ARBDB550R</b>	5-50lb	SBX Dumbbell Set RACKDB10 5lb incs (10 pairs – 20 total)	<b>\$2,965.00</b>
<b>ARBDB575R</b>	5-75lb	SBX Dumbbell Set RACKDB15 5lb incs (15 pairs – 30 total)	<b>\$5,570.00</b>
<b>ARBDB5100R</b>	5-100lb	SBX Dumbbell Set RACKDB10/15 5lb incs (20 pairs – 40 total)	<b>\$9,575.00</b>

### RACK SPECIFICATIONS.

<b>RACKDB10</b>	10 Pair Dumbbell Rigid Rack (as shown) Size: 77" x 27.5" x 30". Weight 132lb.	<b>\$890.00</b>
<b>RACKDB15</b>	15 Pair 3 Shelf Dumbbell Rigid Rack Size: 77" x 27.5" x 45". Weight 176lb.	<b>\$1,170.00</b>

# URETHANE BARBELLS.



**FIXING.**  
Assembled with our unique patented "Dual Lock Plus" process.

**EVOLUTION EDGING.**  
Circle-to-octagon shaping inspires anti-roll confidence.

**KNURL.**  
Precise and defined knurl.

**TOP DOWN NUMBERING.**  
Weight indicators visible from your take off and grip positions.

<b>APUBB2060</b>	20-60lb	Urethane Barbell Set 10lb incs (5 Barbells)	<b>\$1,290.00</b>
<b>APUBB70110</b>	70-110lb	Urethane Barbell Set 10lb incs (5 Barbells)	<b>\$2,200.00</b>
<b>APUBB20110</b>	20-110lb	Urethane Barbell Set 10lb incs (10 Barbells)	<b>\$3,475.00</b>

# URETHANE CURL BARBELLS.

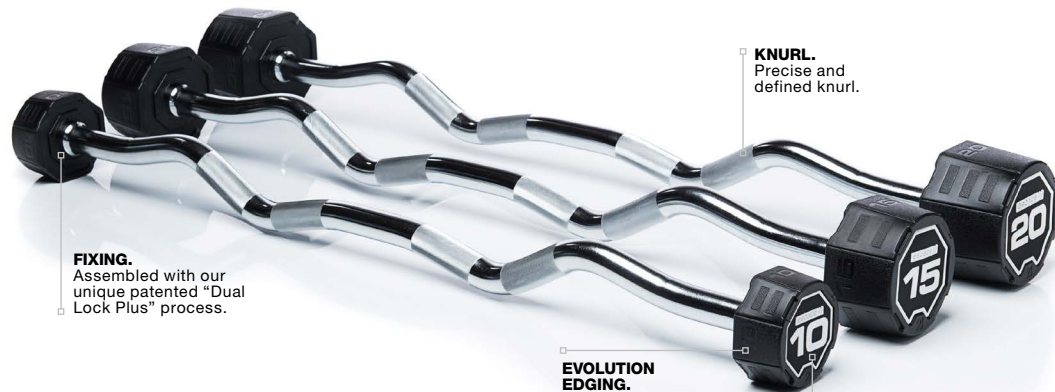

**FIXING.**  
Assembled with our unique patented "Dual Lock Plus" process.

**KNURL.**  
Precise and defined knurl.

**EVOLUTION EDGING.**  
Circle-to-octagon shaping inspires anti-roll confidence.

**TOP DOWN NUMBERING.**  
Weight indicators visible from your take off and grip positions.

<b>APUCBB2060</b>	20-60lb	Urethane Curl Barbell Set 10lb incs (5 Barbells)	<b>\$1,415.00</b>
<b>APUCBB70110</b>	70-110lb	Urethane Curl Barbell Set 10lb incs (5 Barbells)	<b>\$2,325.00</b>
<b>APUCBB20110</b>	20-110lb	Urethane Curl Barbell Set 10lb incs (10 Barbells)	<b>\$3,740.00</b>
<b>APUMBB2060</b>	20-60lb	Urethane Barbell & Curl Barbell Set 10lb incs (5 Barbells and 5 Curl Barbells)	<b>\$2,700.00</b>

# URETHANE BARBELL SETS WITH RIGID RACK.



**URETHANE BARBELL SETS WITH RACK.**

<b>APUBB2060R</b>	20-60lb	Urethane Barbell Set RACKBB5 (5 Barbells)	<b>\$1,970.00</b>
<b>APUBB70110R</b>	70-110lb	Urethane Barbell Set RACKBB5 (5 Barbells)	<b>\$2,880.00</b>
<b>APUBB20110R</b>	20-110lb	Urethane Barbell Set RACKBB10 (10 Barbells)	<b>\$4,380.00</b>

**URETHANE CURL BARBELL SETS WITH RACK.**

<b>APUCBB2060R</b>	20-60lb	Urethane Curl Barbell Set RACKBB5 (5 Barbells)	<b>\$2,095.00</b>
<b>APUCBB70110R</b>	70-110lb	Urethane Curl Barbell Set RACKBB5 (5 Barbells)	<b>\$3,000.00</b>
<b>APUCBB20110R</b>	20-110lb	Urethane Curl Barbell Set RACKBB10 (10 Barbells)	<b>\$4,645.00</b>
<b>APUMBB2060R</b>	20-60lb	Nucleus Urethane & Curl Barbell Set RACKBB10	<b>\$3,610.00</b>

**RACK SPECIFICATIONS.**

<b>RACKBB5</b>	5 Barbell Rigid Rack (single sided) Size: 46" x 27.5" x 45". Weight 68lb.	<b>\$690.00</b>
<b>RACKBB10</b>	10 Barbell Rigid Rack (as shown) Size: 46" x 27.5" x 45". Weight 79lb.	<b>\$920.00</b>

STRENGTH.

# KETTLEBELLS.

Escape's comprehensive range of kettlebells has an option to suit every workout intensity. From tough cross training gyms to chic, boutique PT studios, all our kettlebells incorporate the highest quality materials to ensure there's a perfect match for every member.



## COMPARISON CHART.

FEATURES.	COMPETITION PRO KETTLEBELLS 2.0.	SBX KETTLEBELLS.	STUDIO KETTLEBELLS.
USE	Kettlebell sport lifting, cross training	Free weight areas for strength training and traditional workouts	Studio workouts, group training
BELL MATERIAL	Carbon steel with hollow core	Rubber covered cast iron core	Vinyl dip with a cast iron core
HANDLE	Cast stainless steel with a satin chrome finish	Hard satin chrome patented handle to bell connection	Cast iron
FEATURE	Powder coated and engraved weight indicators	Textures and grooves across the kettlebell allow for more dynamic grip options	Vinyl coating and colors
TOLERANCE	+/- 2%	+/- 2%	+/- 3%
WEIGHTS	8-32kg in 4kg increments (equivalent to 18lb-70lb in 8lb increments)	10lb, 15lb, 20lb, 25lb, 35lb, 45lb, 50lb and 60lb	8lb-40lb in 8lb increments
WARRANTY	2 years	3 years	1 year

## COMPETITION PRO KETTLEBELLS 2.0.

The heavy-duty choice for clubs and members who take their lifting seriously. Uniform size and industry standard color coding to meet competition standards. Cast stainless steel handles won't rust, and extra-tough powder coating with engraved weight indicators ensure life-long visibility.



STRENGTH.

## SBX KETTLEBELLS.

The innovative SBX kettlebell range offers a high level of practicality that lasts. Textures and grooves allow for more grip options with dynamic feedback when shifting weight, while the hard satin chromed and salt tested handles ensure longevity.



## STUDIO KETTLEBELLS.

Gentle on your grip as well as your flooring. The cast iron bell is vinyl dipped with bright colors so you can easily organize your collection by weight. Durable and versatile, these best-selling, effective weights start at 4lbs, making them a great entry-level option.





# COMPETITION PRO KETTLEBELLS 2.0.



<b>CKB208</b>	8kg/18lb	Competition Pro Kettlebell 2.0 – Purple	<b>\$142.00</b>
<b>CKB212</b>	12kg/26lb	Competition Pro Kettlebell 2.0 – Blue	<b>\$160.00</b>
<b>CKB216</b>	16kg/35lb	Competition Pro Kettlebell 2.0 – Yellow	<b>\$211.50</b>
<b>CKB220</b>	20kg/44lb	Competition Pro Kettlebell 2.0 – Gray	<b>\$239.00</b>
<b>CKB224</b>	24kg/53lb	Competition Pro Kettlebell 2.0 – Green	<b>\$266.50</b>
<b>CKB228</b>	28kg/62lb	Competition Pro Kettlebell 2.0 – Orange	<b>\$294.00</b>
<b>CKB232</b>	32kg/70lb	Competition Pro Kettlebell 2.0 – Red	<b>\$337.50</b>
<b>TRAIN03</b>	Kettlebell Product Training Workshop		<b>\$79.00</b>

**HOLLOW CORE.**  
Hollow core design that enables more of the weight to be distributed closer to the handle rather than the base.

**BASE.**  
The wide, flat base is perfect for renegade rows and push-ups.

**HANDLE.**  
Cast stainless steel handles that won't rust

STRENGTH.

## COMPETITION KETTLEBELL SETS WITH OCTAGON RACK.

Keep kettlebells in competition condition with the durable Octagon Racks. Our high-grade steel racks are made in the UK. Heavy-duty and bold, these racks reduce your storage footprint but max out practicality. Link them to each other, attach to an Octagon frame – bolt-down or freestanding.



<b>CKB8322L</b>	8-32kg/ 18-70lb	x2 Competition Kettlebell Set ULLSS11 8lb incs (14 Kettlebells total)	<b>\$4,525.00</b>
<b>TMAT11</b>	Top Rubber Mat 1.1m		<b>\$21.00</b>
<b>TRAIN03</b>	Kettlebell Product Training Workshop		<b>\$79.00</b>
<b>RACK SPECIFICATIONS.</b>			
<b>ULLSS11</b>	Ultra Low Level Octagon Storage Solution 1.1m Holds 14 Competition Kettlebells (as shown) Size: 53" x 16" x 30". Weight 110lb.		<b>\$1,210.00</b>
<b>Kettlebells sold individually.</b>			

## COMPETITION KETTLEBELL SETS WITH RIGID RACK.

Maximize floor space with these cost-effective Rigid Racks. Made from affordable, lightweight steel with feet that can be turned inwards to stand rack units next to each other. Designed to be practical and discreet whilst minimizing material and cost.



<b>CKB8322R</b>	8-32kg/ 18-70lb	x2 Competition Kettlebell Set RACKKB2 8lb incs (14 Kettlebells total)	<b>\$4,240.00</b>
<b>TRAIN03</b>	Kettlebell Product Training Workshop		<b>\$79.00</b>
<b>RACK SPECIFICATIONS.</b>			
<b>RACKKB2</b>	Rigid Kettlebell Rack Holds 14 Competition Kettlebells (as shown) Size: 62" x 27.5" x 30". Weight 117lb.		<b>\$960.00</b>
<b>Kettlebells sold individually.</b>			

# SBX KETTLEBELLS.

As one of the first manufacturers to launch an SBX kettlebell, our experience and rigorous testing has resulted in the Nucleus SBX Kettlebell. Enhanced design, ergonomic improvements but with an efficient manufacturing process.



**SALT TESTED.**  
Hard satin chromed handles have been salt tested to last.

**HANDLE.**  
Patented "fish tail" welded into cast iron core bell.

**GRIP.**  
360-degree grip and dynamic feedback.

**LONGEVITY.**  
Hard-wearing, durable SBX coating designed to prevent damage to surfaces.

**NUMBERING.**  
Oversized numbering for fast weight identification.

<b>ARBKB10</b>	10lb	SBX Kettlebell	<b>\$93.00</b>
<b>ARBKB15</b>	15lb	SBX Kettlebell	<b>\$111.00</b>
<b>ARBKB20</b>	20lb	SBX Kettlebell	<b>\$129.00</b>
<b>ARBKB25</b>	25lb	SBX Kettlebell	<b>\$147.00</b>
<b>ARBKB35</b>	35lb	SBX Kettlebell	<b>\$183.00</b>
<b>ARBKB45</b>	45lb	SBX Kettlebell	<b>\$219.00</b>
<b>ARBKB50</b>	50lb	SBX Kettlebell	<b>\$237.00</b>
<b>ARBKB60</b>	60lb	SBX Kettlebell	<b>\$273.00</b>

<b>ARBKB1060</b>	10-60lb	SBX Kettlebell Set (8 Kettlebells total)	<b>\$1,390.00</b>
------------------	---------	------------------------------------------	-------------------

<b>TRAIN03</b>	Kettlebell Product Training Workshop	<b>\$79.00</b>
----------------	--------------------------------------	----------------

**Kettlebells sold individually.**



**ARBKB10602L.**

# SBX KETTLEBELL SETS WITH RACKS.

The Kettlebell Rigid Rack is designed to provide a slimmer, subtler and cost-effective option in comparison to the Octagon Rack. A 2-shelf rack option, the Rigid Rack efficiently tucks away against a flat surface, safely storing the kettlebells to free up the gym floor space.

STRENGTH.



<b>ARBKB10602R</b>	10-60lb SBX Kettlebell Set x2 RACKKB2 (as shown above) (16 Kettlebells total)	<b>\$3,725.00</b>
--------------------	-------------------------------------------------------------------------------	-------------------

<b>ARBKB10602L</b>	10-60lb SBX Kettlebell Set x2 ULLSS11 (as shown on page 32) (16 Kettlebells total)	<b>\$4,000.00</b>
--------------------	------------------------------------------------------------------------------------	-------------------

<b>RACK SPECIFICATIONS.</b>		
<b>RACKKB2</b>	Rigid Kettlebell Rack Holds 16 SBX Kettlebells Size: 62" x 27.5" x 30". Weight 117lb.	<b>\$960.00</b>
<b>ULLSS11</b>	Ultra Low Level Octagon Storage Solution 1.1m Holds 16 SBX Kettlebells Size: 53" x 16" x 30". Weight 110lb.	<b>\$1,210.00</b>

# STUDIO KETTLEBELLS.

These durable Studio Kettlebells are gentle on your grip as well as your flooring. Exceptionally well-designed, the cast iron bell is vinyl dipped with bright colors so you can easily organize your collection by weight.



**NUMBERING.**  
Oversized numbering for fast weight identification.

**HANDLE.**  
Made to sit comfortably in the hand so members can concentrate on their workout.

**PROTECTS.**  
Vinyl dip means studio floors will be protected.

**LONG LASTING.**  
Cast Iron construction with a vinyl dip covering means these kettlebells will last longer.

<b>AVKB04</b>	4lb	Studio Vinyl Kettlebell - Green	<b>\$15.00</b>
<b>AVKB08</b>	8lb	Studio Vinyl Kettlebell - Blue	<b>\$30.00</b>
<b>AVKB12</b>	12lb	Studio Vinyl Kettlebell - Red	<b>\$45.00</b>
<b>AVKB16</b>	16lb	Studio Vinyl Kettlebell - Gray	<b>\$60.00</b>
<b>AVKB20</b>	20lb	Studio Vinyl Kettlebell - Black	<b>\$75.00</b>
<b>AVKB24</b>	24lb	Studio Vinyl Kettlebell - Green	<b>\$90.00</b>
<b>AVKB28</b>	28lb	Studio Vinyl Kettlebell - Blue	<b>\$105.00</b>
<b>AVKB32</b>	32lb	Studio Vinyl Kettlebell - Red	<b>\$120.00</b>
<b>AVKB36</b>	36lb	Studio Vinyl Kettlebell - Gray	<b>\$135.00</b>
<b>AVKB40</b>	40lb	Studio Vinyl Kettlebell - Black	<b>\$150.00</b>
<b>TRAIN03</b>		Kettlebell Product Training Workshop	<b>\$79.00</b>

Kettlebells sold individually.



**RACKKB2.**

# KETTLEBELL RACKS.

We offer two lines of kettlebell storage racks to ensure the right solution. Both offer a 2 shelf option but the Octagon Racks are aesthetically bolder, designed with durability and heavy-duty usage in mind.

**RACK SPECIFICATIONS.**

<b>ULLSS11</b>	Ultra Low Level Octagon Storage Solution 1.1m Holds up to 4 sets of 8-40lb 20 Studio Kettlebells (as shown) Size: 53" x 16" x 30". Weight 110lb.	<b>\$1,210.00</b>
<b>ULLSS17</b>	Low Level Octagon Storage Solution 1.7m Size: 16" x 78" x 30". Weight 201lbs.	<b>\$1,530.00</b>
<b>RACKKB2</b>	Rigid Kettlebell Rack Holds up to 4 sets of 8-40lb. 20 Studio Kettlebells (as shown on page 34) Size: 62" x 27.5" x 30". Weight 117lb.	<b>\$960.00</b>



# DUMBBELL AND KETTLEBELL SETS WITH RIGID RACK.

Keep dumbbells and kettlebells stored safely but easily accessible with our racks. For the complete storage solution, we have selected some rack combinations based on our bestsellers.



<b>AKB1060PU550R</b>	5-50lb Urethane Dumbbells 5lb incs, (10 pairs, 20 total), 10-60lb SBX Kettlebell Set (8 Kettlebells total) RACKKD	<b>\$5,540.00</b>
<b>AKB1060RB550R</b>	5-50lb SBX Dumbbells 5lb incs, (10 pairs, 20 total), 10-60lb SBX Kettlebell Set (8 Kettlebells total) RACKKD	<b>\$4,740.00</b>
<b>AKB10452PU550R</b>	5-50lb Urethane Dumbbells 5lb incs, (10 pairs, 20 total), 10-45lb SBX Kettlebell Set x 2 (12 Kettlebells total) RACKKD.	<b>\$5,910.00</b>
<b>AKB10452RB550R</b>	5-50lb SBX Dumbbells 5lb incs, (10 pairs, 20 total), 10-45lb SBX Kettlebell Set x 2 Kettlebells total) RACKKD.	<b>\$5,110.00</b>

**RACK SPECIFICATIONS.**

<b>RACKKD</b>	Rigid Kettlebell and Dumbbell Rack Holds up to 10 Dumbbell pairs and 12 Kettlebells. Size: 77" x 27.5" x 45" (as shown)	<b>\$1275.00</b>
---------------	-------------------------------------------------------------------------------------------------------------------------------	------------------

# PLATES.

Whatever your lifting needs – technique, training or competition – our comprehensive collection of plates means there’s a solution for you. Enhancing the essential functionality of each plate without taking away from its primary purpose. Bright and engaging colors have been cleverly combined with high-quality materials to create a range that will inject energy and give your free weight area the ultimate USP.



## COMPARISON CHART.

FEATURES.	URETHANE GRIP PLATES.	RUBBER GRIP PLATES.	ELITE URETHANE BUMPER PLATES.	RUBBER BUMPER PLATES.
USE	Heavy use, strength training spaces	Demanding training environments, Olympic lifting, cross training	Heavy use facilities, Olympic lifting, cross training	Olympic lifting
MATERIAL	Urethane, Cast Iron, Stainless Steel core	Cast Iron, Rubber, Stainless Steel core	Urethane, Cast Iron, Machined Steel core	Solid Rubber, Stainless Steel core
WEIGHTS/ THICKNESS	2.5lb - 0.8" 5lb - 0.9" 10lb - 1.1" 25lb - 1.6" 35lb - 1.7" 45lb - 1.7"	2.5lb - 0.8" 5lb - 0.95" 10lb - 1.2" 25lb - 1.6" 35lb - 1.7" 45lb - 1.7"	10lb - 1" 25lb - 1" 35lb - 1.5" 45lb - 2" 55lb - 2.5"	10lb - 1.37" 25lb - 1.37" 35lb - 1.81" 45lb - 2.28"
DUROMETER RATING (HARDNESS*)	80°	68 - 75	89°	-
INTERNAL DIAMETER	2"	2"	2"	2"
WEIGHT TOLERANCE	+/- 10%	+/- 10%	+/- 2%	+/- 2%
WARRANTY	7 years	1 year	3 years	1 year

\*The higher the hardness rating the less bounce.

# HOW TO CHOOSE.

## URETHANE GRIP PLATES.

Designed with cut-outs to allow you to separate plates and prevent them locking together. Made from hardwearing Urethane, with side numbering for easy weight identification, these plates have stainless steel centers and optional laser engraving or text PU filling for custom branding options.



## RUBBER GRIP PLATES.

There is a lot of choice when it comes to buying bumper plates for your facility. The Rubber Grip Plates are great all-rounders, with a simple no-fuss design. These plates are versatile and durable, built to last, lift after lift.



## ELITE URETHANE BUMPER PLATES.

Outstanding durability, tight weight tolerances and low-bounce performance set these plates apart for the ultimate Olympic lifting experience. Inbuilt grip inserts and grip lips, enhanced vibrant colors and clear weight numbers make these plates appealing and accessible.



## RUBBER BUMPER PLATES.

These rubber bumper plates are impact absorbing and scratch resistant. The design of these back-to-basics bumper plates might seem simple in aesthetics but they are an effective way of bulking out any barbell set up.



STRENGTH.

# URETHANE GRIP PLATES.

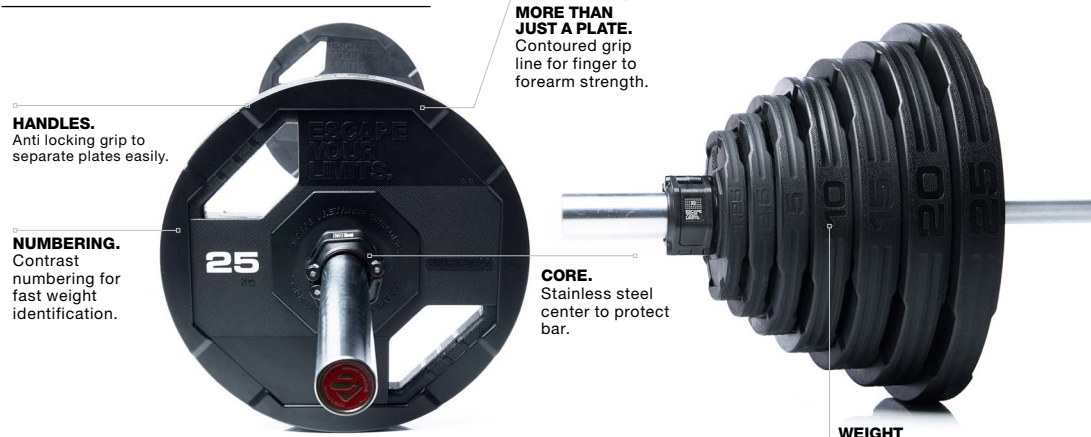

**HANDLES.**  
Anti locking grip to separate plates easily.

**NUMBERING.**  
Contrast numbering for fast weight identification.

**MORE THAN JUST A PLATE.**  
Contoured grip line for finger to forearm strength.

**CORE.**  
Stainless steel center to protect bar.

**WEIGHT INDICATORS.**  
Easy weight identification on a bar or rack.

<b>APUGD025</b>	2.5lb	Urethane Grip Disc	<b>\$38.00</b>
<b>APUGD050</b>	5lb	Urethane Grip Disc	<b>\$47.50</b>
<b>APUGD100</b>	10lb	Urethane Grip Disc	<b>\$71.50</b>
<b>APUGD250</b>	25lb	Urethane Grip Disc	<b>\$140.00</b>
<b>APUGD350</b>	35lb	Urethane Grip Disc	<b>\$188.00</b>
<b>APUGD450</b>	45lb	Urethane Grip Disc	<b>\$235.50</b>

**URETHANE GRIP PLATE SETS.**

<b>APUGD2452</b>	2.5-45lb	Urethane Grip Discs (2 of ea)	<b>\$1,440.00</b>
<b>APUGD2454</b>	2.5-45lb	Urethane Grip Discs (4 of ea)	<b>\$2,875.00</b>

# RUBBER GRIP PLATES.

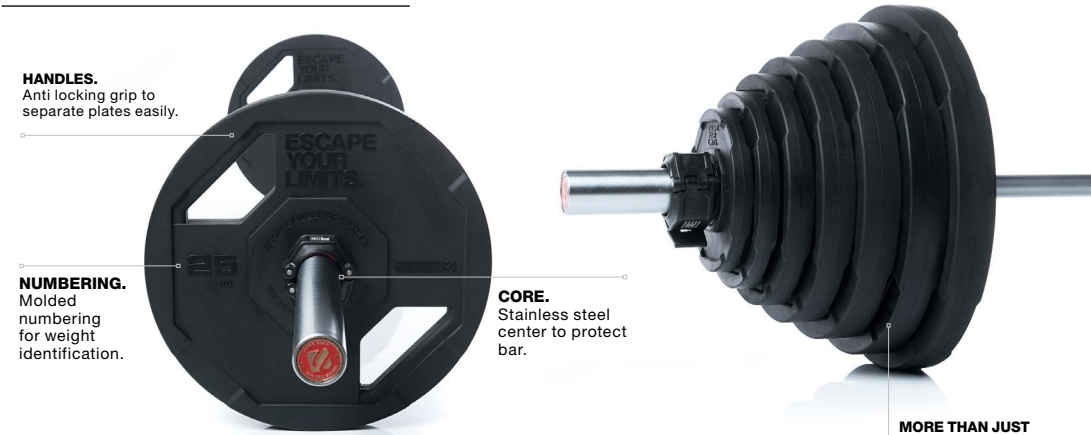

**HANDLES.**  
Anti locking grip to separate plates easily.

**NUMBERING.**  
Molded numbering for weight identification.

**CORE.**  
Stainless steel center to protect bar.

**MORE THAN JUST A PLATE.**  
Contoured grip line for finger to forearm strength.

<b>ARBGD02</b>	2.5lb	Rubber Grip Disc	<b>\$8.00</b>
<b>ARBGD05</b>	5lb	Rubber Grip Disc	<b>\$16.00</b>
<b>ARBGD10</b>	10lb	Rubber Grip Disc	<b>\$32.00</b>
<b>ARBGD25</b>	25lb	Rubber Grip Disc	<b>\$80.00</b>
<b>ARBGD35</b>	35lb	Rubber Grip Disc	<b>\$112.00</b>
<b>ARBGD45</b>	45lb	Rubber Grip Disc	<b>\$144.00</b>

# GRIP PLATE SETS WITH WEIGHT TREE.



STRENGTH.

<b>URETHANE GRIP PLATES RACK SET.</b>		
<b>APUGD2454R</b>	2.5-45lb Urethane Grip Disc (4 of ea)	<b>\$3,295.00</b>
<b>RACK SPECIFICATIONS.</b>		
<b>WTREE2</b>	Weight Tree	<b>\$435.00</b>
	Holds up to 28 plates. 4 plates per pin.	
	Size: 27.5" x 27.5" x 52"	
	Max load 490lb. Weight 47lb.	



**HARD-WEARING.**

Urethane over a steel core shrugs off impacts to stay looking new for longer.

**CORE.**

Durable machined steel center to protect bar.

**GRIPPABLE.**

Grippable ridge and finger castellations to make them easy to pick up and handle, whether vertical or horizontal.

## ELITE URETHANE BUMPER PLATES.

For the best Olympic lifting experience, try Elite plates. Durable and 'low bounce' thanks to the Urethane, and especially tight weight tolerances, these plates deliver on every lift.

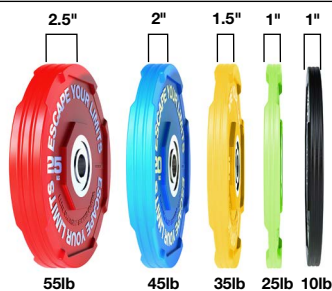

<b>APUBP10</b>	10lb Elite Urethane Bumper Plate – Black	<b>\$150.50</b>
<b>APUBP25</b>	25lb Elite Urethane Bumper Plate – Green	<b>\$262.50</b>
<b>APUBP35</b>	35lb Elite Urethane Bumper Plate – Yellow	<b>\$321.00</b>
<b>APUBP45</b>	45lb Elite Urethane Bumper Plate – Blue	<b>\$379.50</b>
<b>APUBP55</b>	55lb Elite Urethane Bumper Plate – Red	<b>\$438.00</b>

**RACK SPECIFICATIONS.**

<b>OTR001</b>	Toast Rack	<b>\$675.00</b>
	Holds 2x complete sets of Elite Bumper Plates	
	Size: 43" x 12" x 12". Weight 59.5lb.	

Plates sold individually.



STRENGTH.

**GRIPPABLE.**

Grippable ridge and finger castellations to make them easy to pick up and handle, whether vertical or horizontal.

**HIGH-STRENGTH.**

High-strength rubber shrugs off impacts to stay looking new for longer.

**CORE.**

Strong stainless-steel pressed center.

## RUBBER BUMPER PLATES.

These high-strength plates shrug off impact with minimal bounce and are molded with weight indicators. They may have a simple design, but are built to last, lift after lift.



<b>ARBBP10</b>	10lb Rubber Bumper Plate	<b>\$67.00</b>
<b>ARBBP25</b>	25lb Rubber Bumper Plate	<b>\$109.00</b>
<b>ARBBP35</b>	35lb Rubber Bumper Plate	<b>\$142.50</b>
<b>ARBBP45</b>	45lb Rubber Bumper Plate	<b>\$181.00</b>

**RACK SPECIFICATIONS.**

<b>OTR001</b>	Toast Rack	<b>\$675.00</b>
	Holds 2x complete sets of Rubber Bumper Plates	
	Size: 43" x 12" x 12". Weight 59.5lb.	

Plates sold individually.



# BARS.

From the very first coaching sessions through to Olympic lifts, Escape has a bar to cover all bases. Made from quality materials to exacting specifications, across this range there's a bar to enable every user to lift harder and heavier in total confidence.



## COMPARISON CHART.

FEATURES.	CURL BAR.	WOD BAR.	POWER BAR.
<b>USE</b>	Strength Training	Cross Training	Strength Training
<b>WEIGHT</b>	20lb	44lb	44lb
<b>LENGTH</b>	3' 9"	7' 2"	7' 2"
<b>SHAFT DIAMETER</b>	1"	1"	1"
<b>SLEEVE LENGTH</b>	6"	16"	16"
<b>KNURL</b>	Single mark no center knurl	Single mark no center knurl	Center knurl
<b>SHAFT FINISH</b>	High Alloy Steel	High Alloy Steel	High Alloy Steel
<b>TENSILE STRENGTH</b>	N/A	162k PSI	128k PSI
<b>BUSHING/BEARING</b>	2 bronze bush bearing (1 per sleeve)	8 needle bearing (4 per sleeve)	4 needle bearing (2 per sleeve)
<b>HEAT TREATMENT</b>	N/A	Twice	Twice
<b>MAX LOAD</b>	220lb	1100lb	550lb
<b>WARRANTY</b>	1 year	1 year	1 year
<b>PERFORMANCE</b>			
<b>WHIP</b>	N/A	★★★★★	★★★★★
<b>KNURL COURSENESS</b>	N/A	★★★★★	★★★★★
<b>ROTATION</b>	N/A	★★★★★	★★★★★

★★★★★ = High  
 ★★★★★ = Low

## POWER BAR.

A great cross training all-rounder, and an ideal entry point for anyone progressing to Olympic lifting for the first time.



**POWER01** 44lb Power Bar **\$365.00**

## WOD BAR.

For Olympic lifts with no compromise. Maximum rotation and whip for faster transitions between sections of a snatch or clean and jerk.



**WOD001** 44lb WOD Bar **\$520.00**

## CURL BAR.

A great strength training tool. Keeps your wrists at the perfect angle when performing reps in comfort and safety.



**CURL01** 20lb Olympic Curl Bar **\$137.00**

STRENGTH.

# OLYMPIC BAR HOLDER AND COLLARS.

Intelligent space-saving storage solution for up to nine Olympic barbells placed vertically, maximizing floor space and utilizing a tiny footprint and a range of collars which have been expertly developed and rigorously tested to ensure your plates remain secure at all times, no matter the intensity of the lifting.



- 01. BARH9** Olympic Bar Holder  
Holds up to 9 bars. **\$370.00**  
Size: 19.5" x 19.5" x 10". Weight 39.6lb.
- 02. WODC01** 2" WOD Collar – Black – Pair **\$70.00**  
Internal Diameter 2". Weight 7 oz/0.2 kg.
- 03. SA7113** 2" Olympic Spring Collar – Each **\$10.00**  
Internal Diameter 2". Weight 99 oz/2.8 kg.
- 04. KAMCOL2** 2" Olympic Clamp Collar – Red – Pair **\$22.00**  
Internal Diameter 2". Weight 6 oz/0.17 kg.



# LIFT ZONE.

This heavy-duty and flexible lifting platform offers superb shock absorption, ensuring your flooring is protected from damage and marking.

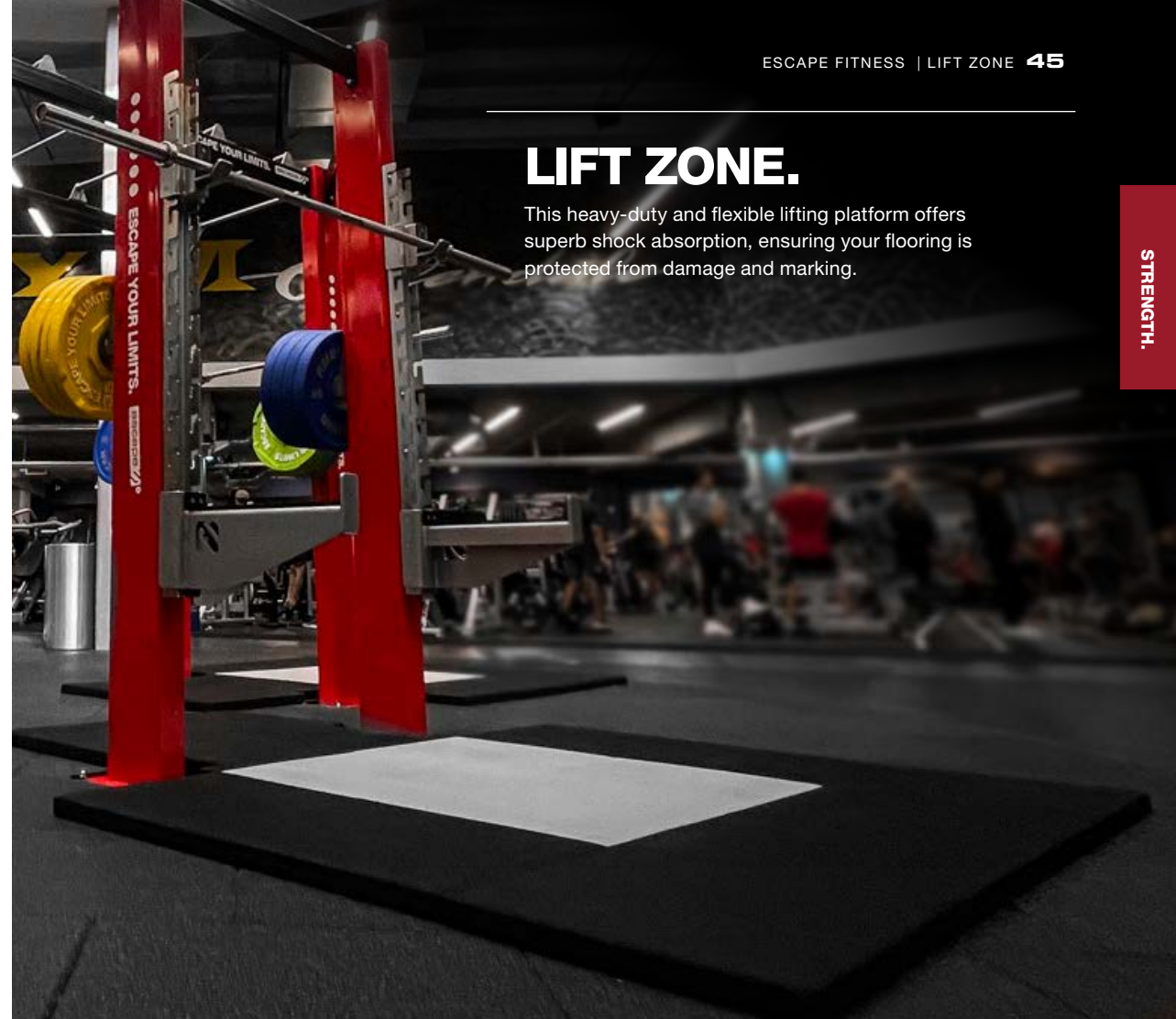

STRENGTH.

The Lift Zone is designed to fit with all of the Octagon range and can be partnered with a single, double or freestanding frame. It's grippy, yet portable and easy to assemble or disassemble. Speak to a sales representative for more information.

- LIFTPLAT3** Lift Zone Basic Small **\$756.00**
- LIFTPLAT4** Lift Zone Basic Large **\$1,404.00**
- LIFTPLAT5** Integrated Lift Zone - Single Leg **\$1,590.00**
- LIFTPLAT6** Integrated Lift Zone - Double Leg **\$1,685.00**
- LIFTPLAT7** Integrated Lift Zone - Freestanding Leg **\$1,685.00**

**SPECIFICATIONS.**  
 Basic Small: 79" x 39" x 1.5". Weight 176lb.  
 Basic Large: 79" x 79" x 1.5". Weight 353lb.  
 Integrated Lift Zone: Lift Zone platform is trimmed to fit frame.  
 Tiles are 19.5" x 39" x 1." thick. (False split at 19.5").

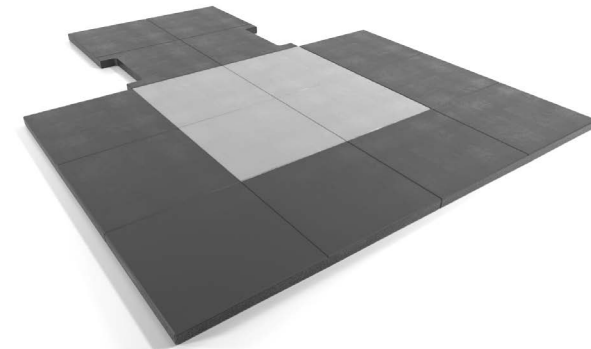



# STRONGBOX.

This revolutionary, all-in-one workout bench will appeal to design conscious gyms who want to attract, and retain members. A next-level training bench, plyo platform and equipment storage unit, STRONGBOX not only demands attention, but speeds up transitions and enhances safety, storing equipment, including Nucleus Dumbbells, neatly to hand.

Using the same steel construction, STRONGBOX's ergonomically designed octagon-shaped back pads allow clearance for exercises while your back remains supported. With an adjustable back rest and a high-density urethane pad to accommodate weighted step ups, this is a dedicated, permanent station that keeps members in one place, for an entire workout.



**PLEASE NOTE:**  
Accessories sold separately.

<b>STRBOX2V2</b>	STRONGBOX	<b>\$2,450.00</b>
<b>ASTRBDB</b>	STRONGBOX with Dumbbells	<b>\$3,250.00</b>
	Includes: 6x Rubber Dumbbells 5lb-30lb	
<b>ASTRBEP</b>	STRONGBOX with Equipment Pack	<b>\$3,700.00</b>
	Includes: 6x Rubber Dumbbells 5lb-30lb, 1 x 20lb and 25lb Rubber Kettlebell, 1 x 11lb VERTMINI, 1 x 17.6lbs GRIPR, 1 x Resistance Tube 02 Green	

**SPECIFICATIONS.**  
Size: 51" x 20" x 20". Weight: 198lb empty.



**SIX LEVEL INCLINE.**  
Fully adjustable back pad.

**INJECTION MOLDED PADS.**  
Injection molded pads are tough and hygienic.

**BACK PADS:**  
Octagon-shaped back pads provide range of motion clearance.

**DUMBBELL PROTECTORS.**  
Urethane encased dumbbells protectors.

**HOOKS.**  
Hooks to attach bands for resistance-focused movements.

**WHEELS:**  
Wheels to make the box easily portable, for storage or workout.

**PRODUCT STORAGE.**  
Shelving for products such as GRIPRs, resistance tubes, medicine balls, or even keys and mobile phones safeguards equipment to free up the gym floor.

STRENGTH.



## ADJUSTABLE BENCH.

A staple of strength training and more, the Adjustable Bench is one of the most versatile workout stations available. Seven levels of incline/decline on the backrest and three on the seat make for a variety of options and flexibility for users to target any area of the body.



**ADJBEN2** Adjustable Bench **\$785.00**

**SPECIFICATIONS.**  
Size: 52" x 16" x 23". Weight 81.5lb.

## DECK 2.0.

With 16 configurations across Step, Ramp and Bench modes, DECK 2.0 is perfect for step, circuits, BODYPUMP™ or Bootcamp workouts, enabling the creation of multiple full body workouts from one training bench. An ideal training tool in 1-on-1 or group environments, pair the DECK 2.0 with our space-saving STAKRBELL dumbbell options and you have a winning combination.

STRENGTH.



**INTELLIGENT GRIP.**  
Texture varies across the surface to match up with the demands of hands or feet in particular areas.

**EQUIPMENT STORAGE.**  
The perfect space for a full set of STAKRBELL and resistance bands, creating a fully equipped workout station.

**ANATOMIC HOT SPOTS.**  
Targets help guide users to where their hands and feet should be on every rep.

**STAKRBELLS.**  
The STAKRBELL tucks away seamlessly in the integrated storage space forming a self-contained training solution. See page 19.

**EST-DECK** DECK 2.0 **\$225.00**

**TRAIN12** DECK 2.0 Product Training Workshop **\$79.00**

**SPECIFICATIONS.**  
Size: 48" x 14" x 8" (flat), 38" (extended). Weight 28.7lb.

# STEP PLATFORM SOLUTION.

Use a single STEP for classic step exercises, raise the height with RISERS for more challenge, or create an inclined platform for extra stepping options or bench work. Versatility is guaranteed and it's easy to switch between configurations mid-workout.

Both platform and riser are made from polypropylene that's strong yet allows a little 'give' to protect joints, whilst the anti-slip properties of the top mat and stabilizing blocks mean even rapid movements can be performed safely.

STEP.



RISERS RAISING STEP.

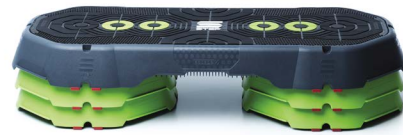

RISERS RAISING STEP INTO INCLINE POSITION.



**ANATOMIC HOT SPOTS.**

Precise targets as a guide for correct foot and hand positions, and to hit in combinations for endless variety and challenge.



**HEAT WELDED TOP MATS.**

Instead of simply gluing the mats to the STEP and RISER they are attached via more robust heat welding for long-term performance.

**LOCKING CONNECTORS.**

Line up the red connectors and a firm push locks STEPs and RISERS securely together.

**REGISTERED DESIGN.**

<b>STEP01</b>	x1 STEP	<b>\$114.50</b>
<b>STEP03</b>	x3 STEPs Pack	<b>\$335.00</b>
<b>STEP04</b>	x1 STEP and x2 RISERS	<b>\$197.00</b>
<b>STEP05</b>	x1 STEP and x4 RISERS	<b>\$280.00</b>
<b>STEP07</b>	STEP Club Pack (x3 STEPs and x6 RISERS)	<b>\$570.00</b>

**SPECIFICATIONS.**

**STEP01:** Size: 42" x 17.5" x 4" Weight 13.7lb.

# THE ESCAPE RISER.

The Escape RISER increases the height of the STEP platform or is a stepping platform in its own right. Wide enough to step on, but narrow enough to straddle – the RISER can be used to create dynamic workouts that get the user moving in all planes of motion.

The riser is inexpensive, and yet extremely versatile. Incorporate it into strength work to increase the distance to floor and therefore the depth and range of motion, enhancing the muscle recruitment.



<b>STEP02</b>	x1 RISER	<b>\$43.50</b>
<b>STEP06</b>	x6 RISER Pack	<b>\$242.00</b>

**SPECIFICATIONS.**

**STEP02:** Size: 17" x 17" x 4" Weight 4.1lb.



STRENGTH.

# OCTAGON.

There is one piece of equipment that grabs user attention like no other – the challenging and versatile functional frame.

With endless configuration possibilities, Escape's Octagon range stands out from the rest. Suitable for members of all fitness levels, from beginner to athlete, our functional frames and storage-focused products deliver comprehensive solutions to optimize any training environment.

THE OCTAGON	
FRAME RANGE	54
T1 TOWER	56
HIT HUBS	60
HTS	68
OCTAGON	74
SQUAT FRAMES	76
BOXING FRAMES	82
ATTACHMENTS	86
FRAME DESIGN	92

# THE OCTAGON FRAME RANGE.

Escape offers multiple configurations of frames, all which can be further customized with innovative storage solutions and optional attachments to create the ultimate training environment.

From compact, corner solutions that bring to life underutilized areas through to eye-catching centerpieces that demand attention, our range offers unrivalled flexibility.

Here are some options to get your started.



## T1 TOWER.

A versatile, entry-level frame great for small areas. Available off the shelf or fully customizable.



## WALL-BASED FRAMES.

Fully customizable, modular HIT HUBs with attachments and integrated storage solutions.



## HTS.

A versatile frame with integrated storage and bridge design to maximize floor space.

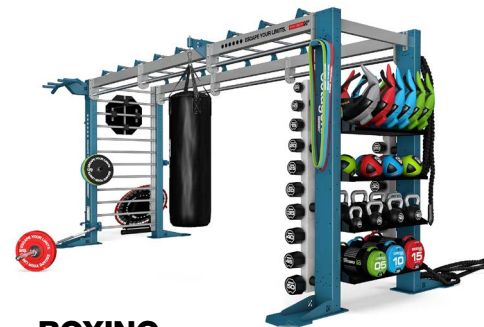

## CORNER.

A tucked-away, training and storage solution that optimizes every inch of space.



## OCTAGON.

The ultimate freestanding or bolt-down frame for a totally loaded, multi-station training experience.



## SQUAT.

A must-have, versatile frame for any club looking to support a serious strength training program.



## BOXING.

Fixed frame or incorporating Escape's unique BOA Rail technology for ultimate training flexibility.



## CUSTOM.

Design your bespoke training environment with Escape's interconnecting modular frame and attachment system.



# T1 TOWER.

Available as an off-the-shelf or a customizable frame, this compact, freestanding, 'entry-level' unit is designed to be the smallest of our range, and also the most affordable. It offers a multitude of exercise options and delivers a highly inclusive exercise experience, ideal for both the fitness beginner through to the seasoned athlete.



## TYPE 01.

### DIMENSIONS.



### ATTACHMENTS.

- x1 Boxing Arm and Swivel.
- x1 Pull-Up Station.
- x1 Fixed Dip Station.
- x1 Claw Step.
- x2 Battle Rope Eye.
- x1 Torso Trainer.
- x1 Bar Holder.
- x1 Weight Horn.



**OFPOT04** T1 Tower - Type 01  
Frame in Standard Colors as shown **\$5,900.00**

**PLEASE NOTE:**  
Frame does not include Bar, Battle Rope, punchbag, plates or TRX.

## TYPE 02.

### DIMENSIONS.



### ATTACHMENTS.

- x1 Boxing Arm and Swivel.
- x1 Crux Rope Pulley.
- x1 Pull-Up Station.
- x1 Fixed Dip Station.
- x1 Claw Step.
- x2 Battle Rope Eye.
- x1 Torso Trainer.
- x1 Weight Horn.



**OFPOT05** T1 Tower - Type 02  
Frame in Standard Colors as shown **\$9,665.00**

**PLEASE NOTE:**  
Frame does not include Bar, Battle Rope, punchbag, plates or TRX.

# T1 TOWER.



## TYPE 03.

### DIMENSIONS.

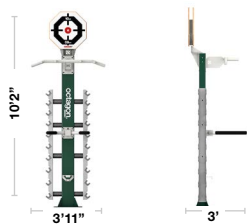

### ATTACHMENTS.

- x1 Pull-Up Station.
- x1 Fixed Dip Station.
- x1 Claw Step.
- x1 Target.
- x2 Holster (holds 10 pairs of Dumbbells).

**FCD05515-010** T1 Tower - Type 03  
 Standard Colors \$5,724.50  
 Color as shown \$6,575.00

**PLEASE NOTE:**  
 Frame does not include Dumbbells.



## TYPE 04.

### DIMENSIONS.



### ATTACHMENTS.

- x1 Adjustable Weight Stack.
- x1 Crux Rope Pulley.
- x1 Pull-Up Station.
- x1 Fixed Dip Station.
- x1 Battle Rope Eye.
- x1 Torso Trainer.
- x1 Bar Holder.
- x1 Weight Horn.

**FCD05515-01N** T1 Tower - Type 04  
 Standard Colors \$14,935.00  
 Color as shown \$14,994.25



**PLEASE NOTE:**  
 Frame does not include Bar,  
 Battle Rope or plates.

## TYPE 05.

### DIMENSIONS.



### ATTACHMENTS.

- x1 Adjustable Weight Stack.
- x1 Pull-Up Station.
- x1 Fixed Dip Station.
- x2 Battle Rope Eye.
- x1 Torso Trainer.
- x1 Bar Holder.

**FCD05515-01M** T1 Tower - Type 05  
 Standard Colors \$11,285.00  
 Color as shown \$11,344.25



**PLEASE NOTE:**  
 Frame does not include Bar,  
 Battle Rope, plates or TRX.

## HIT HUBS.

Bring any training area to life with our expertly designed HIT HUB. Forming part of our Octagon range, the HIT HUB benefits from a modular design that links bays to create the perfect frame that blends in with your space.

Available as single or double sided, bolt down or freestanding, with the option to add storage solutions, the HIT HUB offers a multitude of configurations.

Single sided is ideal for maximizing limited or underused floor space whilst double sided provides zoned divisions, doubling the exercise stations, perfect for group exercise.

# HIT HUB - THE MOST VERSATILE FRAME EVER MADE.





# HIT HUB. 1 BAY SINGLE SIDED, BOLT DOWN FRAMES.

THERE IS NOTHING WE CAN'T DO WHEN WE SET OUR MINDS TO IT.

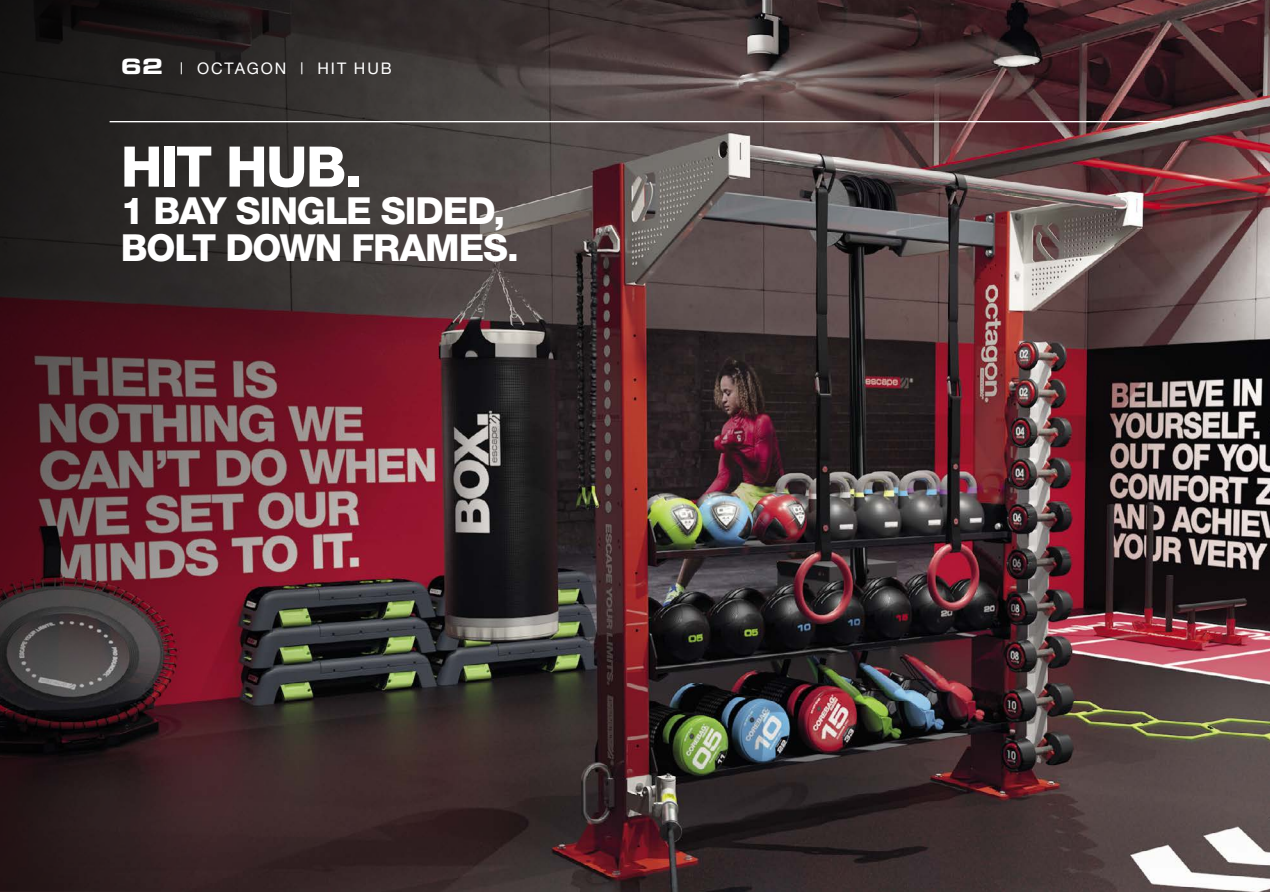

## TYPE 02.

### DIMENSIONS.

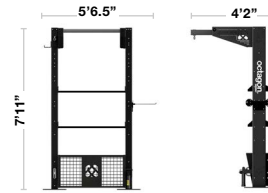

### ATTACHMENTS.

- x1 Internal Hit Wing.
- x1 Battle Rope Eye.
- x1 Claw for Storage.
- x1 Boxing Arm and Swivel.
- x1 Torso Trainer.
- x1 Storage Cage.
- x1 Mat Rack.
- x2 Flat Shelves with rubber mats.



**FCD05515-01D** HIT HUB 1 Bay - Type 02  
Frame in Standard Colors as shown **\$7,741.00**

**PLEASE NOTE:**  
Frame does not include Bar, Battle Rope, Kettlebells, Balls, Punchbag, Mats or TRX.

## TYPE 01.

### DIMENSIONS.

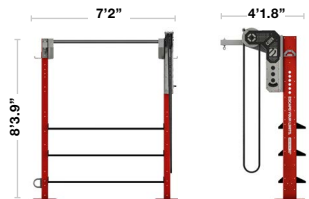

### ATTACHMENTS.

- x1 Battle Rope Eye.
- x2 Claws for Storage.
- x1 Internal Hit Wing.
- x1 Boxing Arm and Swivel.
- x1 Crux Rope Pulley.
- x3 Flat Shelves with rubber mats.



**FCD05515-01E** HIT HUB 1 Bay - Type 01  
Standard Colors **\$10,998.00**  
Color as shown **\$11,224.50**

**PLEASE NOTE:**  
Frame does not include Battle Rope, Kettlebells, Balls, Bags Punchbag, Resistance Bands or WOD Rings.

## TYPE 03.

### DIMENSIONS.



### ATTACHMENTS.

- x1 Internal Hit Wing.
- x1 Adjustable Weight Stack
- x1 Battle Rope Eye.
- x1 Claw for Storage.
- x1 Torso Trainer.
- x3 Flat Shelves with rubber mats.
- x1 Fixed Dip Station.



**FCD05515-01F** HIT HUB 1 Bay - Type 03  
Standard Colors **\$13,813.00**  
Color as shown **\$13,931.50**

**PLEASE NOTE:**  
Frame does not include Bar, Battle Rope, Kettlebells, Balls, Bags, Resistance Bands or WOD Rings.

## TYPE 01.

### DIMENSIONS.

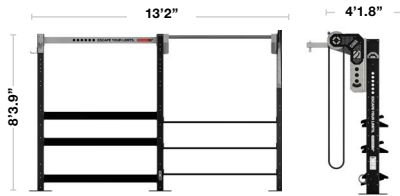

### ATTACHMENTS.

- x1 Internal HIT Wing.
- x1 Battle Rope Eye.
- x1 Claw for Storage.
- x1 Boxing Arm and Swivel.
- x1 Crux Rope Pulley.
- x3 Dumbbell Shelves.
- x3 Flat Shelves with rubber mats.

**FCD05515-011** HIT HUB 2 Bay - Type 01  
Standard Colors **\$13,812.00**  
Color as shown **\$13,949.25**



**PLEASE NOTE:**  
Frame does not include Battle Rope, Kettlebells, Balls, Bags, Dumbbells or WOD Rings.

## TYPE 02.

### DIMENSIONS.

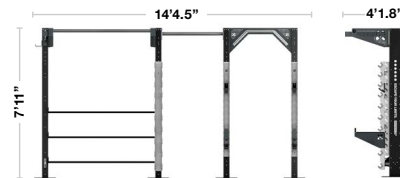

### ATTACHMENTS.

- x1 Internal Hit Wing.
- x1 Battle Rope Eye.
- x1 Claw for Storage.
- x1 Catch Rack Set Pair.
- x1 Extended Catch Rack Pair.
- x1 Boxing Arm and Swivel
- x1 Pull-Up Bar.
- x2 Adjuster Teeth.
- x1 The Holster (holds 5 pairs of Dumbbells).
- x1 Bar Holder
- x3 Flat Shelves with rubber mats.

**FCD05515-01H** HIT HUB 2 Bay - Type 02  
Frame in Standard Color as shown **\$13,780.75**



**PLEASE NOTE:**  
Frame does not include Punchbag, Bar, Plates Battle Rope, Kettlebells, Balls, Bags, Dumbbells or WOD Rings.

## HIT HUB. 2 BAY SINGLE SIDED, BOLT DOWN FRAMES.



## TYPE 03.

### DIMENSIONS.

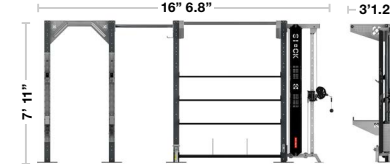

### ATTACHMENTS.

- x1 Internal Hit Wing.
- x1 Adjustable Weight Stack.
- x1 Battle Rope Eye.
- x1 Claw for Storage.
- x1 Catch Rack Set Pair.
- x1 Extended Catch Rack Pair.
- x1 Torso Trainer.
- x1 Pull-Up Bar.
- x2 Adjuster Teeth.
- x1 Parallel Storage Shelf.
- x3 Flat Shelves with rubber mats.

**FCD05515-01G** HIT HUB 2 Bay - Type 03  
Standard Colors **\$19,960.00**  
Color as shown **\$20,182.50**



**PLEASE NOTE:**  
Frame does not include Bar, Battle Rope, Kettlebells, Balls, Bags or WOD Rings.

# HIT HUB. FREESTANDING FRAMES.



## TYPE 01.

**DIMENSIONS.**

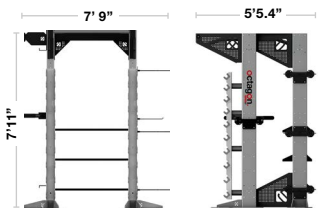

**ATTACHMENTS.**

- x1 Hit Wing 1M.
- x1 T1 Pull-Up Station.
- x1 Fixed Dip Station.
- x2 Claw Step.
- x3 Flat Shelves with rubber mats.
- x1 Mat Rack.
- x3 Gym Ball Holder.
- x2 The Holster (holds 10 pairs of Dumbbells).

**FCD05515-01A** HIT HUB - Freestanding 01  
Standard Colors \$14,351.00  
Color as shown \$14,629.00



**PLEASE NOTE:**  
Frame does not include Dumbbells, Kettlebells,  
Balls, Bags, Mats or TRX.

## TYPE 02.

**DIMENSIONS.**

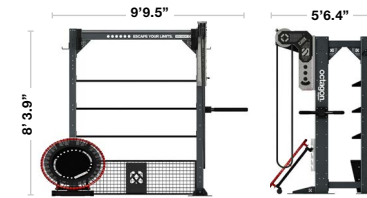

**ATTACHMENTS.**

- x1 Battle Rope Eye.
- x2 Claws for Storage.
- x1 Internal Hit Wing.
- x1 Fixed Dip Station.
- x1 Crux Rope Pulley.
- x1 Pro Bouncer.
- x3 Flat Shelves with rubber mats.
- x1 Storage Cage.

**FCD05515-01B** Hit Hub Freestanding - Type 02  
Frame in Standard Colors was shown \$14,351.00



**PLEASE NOTE:**  
Frame does not include Battle Rope, Kettlebells,  
Balls, Bags, Resistance Bands or TRX.

## TYPE 03.

**DIMENSIONS.**



**ATTACHMENTS.**

- x1 Battle Rope Eye.
- x2 Claws for Storage.
- x2 Internal Hit Wings.
- x1 Boxing Arm.
- x1 Torso Trainer.
- x1 Weight Horn.
- x1 Bar Holder.
- x1 Crux Rope Pulley.
- x2 The Holster (holds 10 pairs of Dumbbells).
- x6 Flat Shelves with rubber mats.

**FCD05515-01C** HIT HUB Freestanding - Type 03  
Standard Colors \$23,370.50  
Color as shown \$23,370.50



**PLEASE NOTE:**  
Frame does not include Battle Rope, Bar, Plates, Kettlebells,  
Dumbbells, Balls, Bags, Resistance Bands or WOD Rings.

# HTS.

The Hub Training System (HTS) can be both freestanding or bolt-down, providing a versatile, all-round functional training system with integrated storage solutions at either end and a bridge design to fully maximize workout space beneath the frame.

With optional monkey bars and additional functional training add-ons, the bridge converts the training space below the frame into an ideal personal training or group fitness workout zone.



## TYPE 01.

### ATTACHMENTS.

- x2 Adjustable Weight Stack.
- x2 Raised Pull-Up Bar.
- x15 Monkey Bar.
- x2 Boxing Arm and Swivel.
- x2 Pull-Up Station.
- x2 Fixed Dip Station.
- x2 Claw Step.
- x2 torso Trainer.
- x2 Bar Holder.
- x2 Battle Rope Eye.
- x2 Dock Target.
- x2 Ladder Wall Target.
- x2 CRUX Rope Pulley.
- x1 Pro Bounder.
- x2 Holsters (holds 10 pairs of Dumbbells).

### DIMENSIONS.

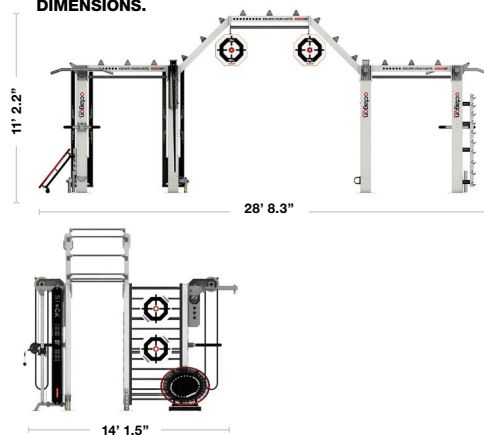

**FCD05515-01R** HTS - Type 01  
 Standard Colors \$67,655.50  
 Color as shown \$68,352.50

**PLEASE NOTE:**  
 Frame does not include Battle Rope, Boxing Bags, Dumbbells, Bars, Plates or WOD Rings.



## TYPE 02.

### ATTACHMENTS.

- x2 Raised Pull-Up Bar.
- x9 Monkey Bar.
- x2 Pull-Up Station.
- x2 Fixed Dip Station.
- x2 Claw Step.
- x2 Battle Rope Eye.
- x2 Dock Target.
- x2 CRUX Rope Pulley.
- x1 BOA Rail with 3 Boxing Bag Carriages.



### DIMENSIONS.

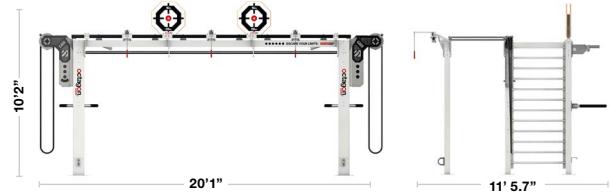

**PLEASE NOTE:**  
Frame does not include Battle Rope, Boxing Bags, TRX or WOD Rings.

<b>FCD05515-01S</b>	HTS - Type 02	
	Standard Colors	\$45,362.00
	Color as shown	\$45,756.00



## TYPE 03.

### ATTACHMENTS.

- x9 Monkey Bar.
- x1 Fixed Dip Station.
- x1 Pull-Up Station.
- x1 Claw Step.
- x1 Claw for Storage.
- x1 Torso Trainer.
- x1 Bar Holder.
- x1 Weight Horn.
- x4 Flat Shelves with rubber mats.
- x1 Ladder Wall Target.
- x1 Battle Rope Eye.
- x1 Pro Bouncer.
- x1 Dock Boxing Bracket.
- x2 Holster (holds 10 pairs of Dumbbells).



### DIMENSIONS.

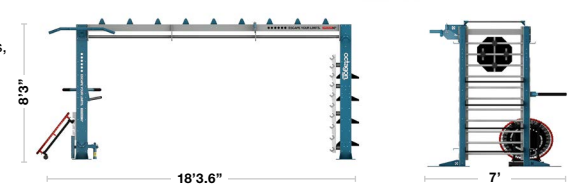

**PLEASE NOTE:**  
Frame does not include Bar, Plates, Battle Rope, Kettlebells, Dumbbells, Balls, Bags, Resistance Bands or Boxing Bag.

<b>FCD05515-01Q</b>	HTS - Type 03	
	Standard Colors	\$23,735.00
	Color as shown	\$25,483.05

# HTS 90

The HTS 90 takes the key features of the HTS concept and rearranges them into something that slots perfectly into corner spaces. It transforms these under-used corner spaces into revenue-generating assets.



## TYPE 01.

### DIMENSIONS.

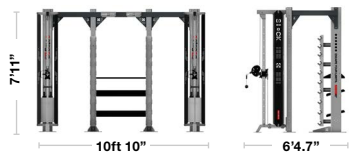

### ATTACHMENTS.

- x2 Adjustable Weight Stacks.
- x1 Set of Pull-Up Handles.
- x2 The Holster (holds 10 pairs of Dumbbells).
- x2 Dumbbell Shelves.
- x1 Flat Shelves with rubber mats.



**FCD05515-01L** HTS90 - Type 01  
 Standard Colors \$22,456.00  
 Color as shown \$22,720.25

**PLEASE NOTE:**  
 Frame does not include Dumbbells or Kettlebells.

## TYPE 02.

### DIMENSIONS.



### ATTACHMENTS.

- x1 Boxing Arm and Swivel.
- x1 Torso Trainer.
- x1 Set of Pull-Up Handles.
- x1 Battle Rope Eye.
- x1 Bar Holder.
- x1 Weight Horn.
- x1 Crux Rope Pulley.
- x1 The Holster (holds 5 pairs of Dumbbells).
- x3 Flat Shelves with rubber mats.



**FCD05515-01K** HTS90 - Type 02  
 Standard Colors \$16,191.25  
 Color as shown \$16,191.25

**PLEASE NOTE:**  
 Frame does not include Bar, Plates, Battle Rope, Kettlebells, Dumbbells, Balls or Bags.

## TYPE 03.

### DIMENSIONS.



### ATTACHMENTS.

- x1 Boxing Arm and Swivel.
- x1 Torso Trainer.
- x1 Set of Pull-Up Handles.
- x1 Fixed Dip Station.
- x1 Battle Rope Eye.
- x1 Bar Holder.
- x1 Weight Horn.
- x3 Flat Shelves with rubber mats.



**FCD05515-01J** HTS90 - Type 03 \$12,056.50  
 Frame in Standard Colors as shown

**PLEASE NOTE:**  
 Frame does not include Bar, Plates, Battle Rope, Kettlebells, Dumbbells, Balls, Bags or Boxing Bag.



# OCTAGON™

The Octagon frame provides an eye-catching, standout, 360 training experience. Designed to be freestanding or bolt-down, this functional, multi-station frame offers an impressive centerpiece that demands attention and takes any training space up a gear.



**REGISTERED DESIGN.**

**PLEASE NOTE:** Frame does not include Bars, Plates, Battle Rope, Kettlebells, Dumbbells, Balls, Bags or Boxing Bag.

**DIMENSIONS.**



**ATTACHMENTS.**

- x4 Monkey Bars.
- x1 Boxing Arm and Swivel.
- x1 Set of Pull-Up Handles.
- x1 Octagon SQR Pull Up Bar.
- x1 CRUX Rope Pulley.
- x2 Battle Rope Eye.
- x1 Fixed Dip Station.
- x4 Weight Horns.
- x1 Torso Trainer
- x2 Weight Stations.
- x2 Catch Rack Set Pair.
- x4 Adjuster Teeth.
- x1 Extended Catch Rack Pair.
- x2 Holster (holds 10 pairs of Dumbbells).
- x5 Flat Shelves with rubber mats.
- x1 Parallel Storage Shelf.

<b>FCD05515-01P</b>	Octagon Freestanding Frame	
	Standard Colors	\$32,740.00
	Color as shown	\$33,702.50

# SQUAT FRAMES.

Those seeking high performance need training facilities to match. With our range of Octagon BOX training frames, elite users have the ideal partner for their squats, presses, pull-ups, big lifts and cardio exercises. These frames give professional sports gyms, universities, colleges and strength-based clubs the ability to provide safe and rewarding workout destinations for their more demanding users.



# HALF BOX.

**DIMENSIONS.**

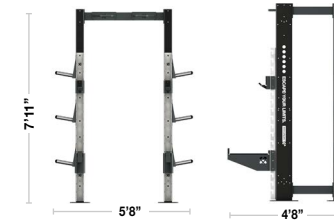

**ATTACHMENTS.**

- x1 Set of Pull-Up Handles.
- x6 Weight Horns.
- x1 Weight Station with Catch Racks and Extended Catch Racks.

**PLEASE NOTE:**  
Frame does not include Bar or Plates.

**OFFSQ10** Half Box **\$9,280.00**  
Frame in Standard Colors as shown



# WOD BOX.

**DIMENSIONS.**



**ATTACHMENTS.**

- x1 Set of Pull-Up Handles.
- x1 Weight Station with Catch Racks and Extended Catch Racks.
- x1 Internal Weight Station with Catch Racks and Safety Straps.

**PLEASE NOTE:**  
Frame does not include Bars or Plates.

**OFFSQ13** WOD Box **\$11,885.00**  
Frame in Standard Colors as shown







## FREESTANDING SQUAT HUB.

### DIMENSIONS.

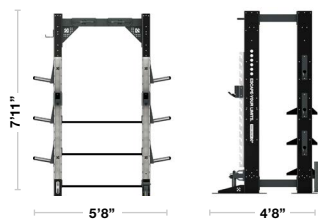

### ATTACHMENTS.

- x1 Set of Pull-Up Handles.
- x1 Battle Rope Eye.
- x1 Torso Trainer.
- x1 Bar Holder.
- x6 Weight Horns.
- x1 Weight Station with Catch Racks.
- x1 Claw for Storage.
- x3 Flat Shelves with rubber mats.



**OFPSQ08** Freestanding Squat Hub Frame in Standard Colors as shown **\$12,390.00**

**PLEASE NOTE:** Frame does not include Bar, Plates, Battle Rope, Kettlebells, Balls or Bags.



## OCTAGON QUAD™.

### DIMENSIONS.

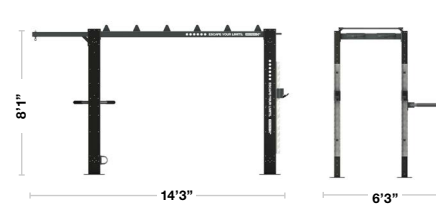

### ATTACHMENTS.

- x1 Boxing Arm and Swivel.
- x1 Battle Rope Eyes.
- x1 Fixed Dip Station.
- x1 Set of Pull-Up Handles.
- x6 Monkey Bars.
- x2 Weight Horns.
- x1 Weight Station with Catch Racks.



**OFPT03** QUAD 2.0 Frame in Standard Colors as shown **\$12,390.00**

**PLEASE NOTE:** Frame does not include Bar, Plates, Battle Rope or Boxing Bag.

# FREESTANDING MONO.

**DIMENSIONS.**

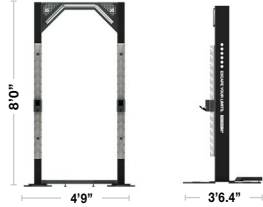

**ATTACHMENTS.**

- x1 Weight Station with Catch Racks.
- x1 Pull-Up Bar.

**OFFSQ12** Freestanding Mono Frame in Standard Colors as shown **\$5,320.00**

**PLEASE NOTE:** Frame does not include Bar or Plates.

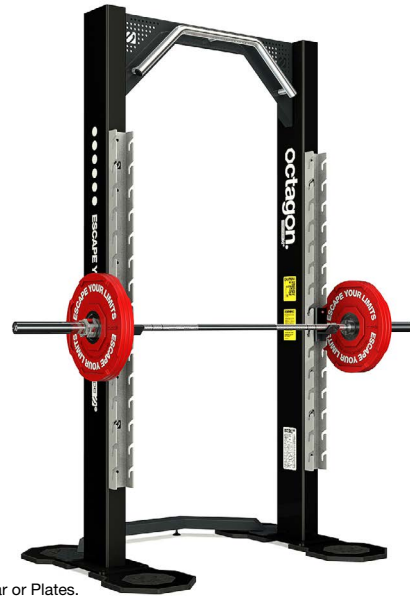

# HALF SQUAD.



**PLEASE NOTE:** Frame does not include Bars, Plates, Dumbbells, Balls or Bags.

**ATTACHMENTS.**

- x2 Sets of Pull-Up Handles.
- x2 Dumbbell Shelves.
- x1 Flat Shelf.
- x1 Storage Rail.
- x2 Catch Rack Pairs.
- x2 Weight Stations.
- x2 Extended Catch Rack Pairs.
- x6 Weight Horns.

**DIMENSIONS.**



**OFFSQ11** Half Squad Frame in Standard Colors as shown **\$21,115.00**

**OFFSQ09** Freestanding Half Squad Frame in Standard Colors **\$23,740.00**



OCTAGON.

## BOXING.

Kicking, punching, jabbing and striking are all perfect for developing speed, strength, power and dexterity. Create a perfect combat training environment with our fixed bag frames or our HTS BOA Rail technology.

# PACKING A PUNCH.



## BOA RAIL.

The BOA Rail is a modular, secure anchor point for punch bags, which also enables trainers to quickly transition seamlessly from bag work into other complimentary training methods thanks to the user-friendly lock/unlock mechanisms.

### WORKING POSITION.

Depending on the size of frame chosen, the BOA Rail provides capacity for two, three or four punchbags to be used at the same time.

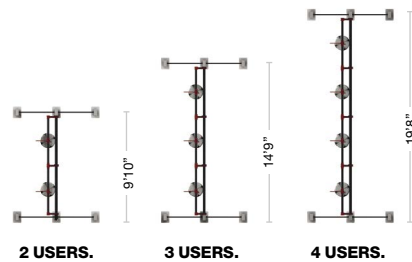

### DOCKED POSITION.

When the boxing session is over, simply release the locking mechanism and slide each bag over for neat storage.

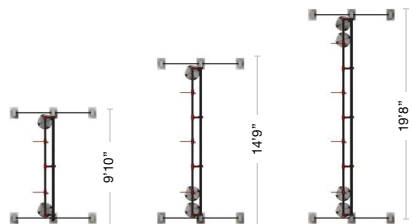

**FCD05515-01T** 20 Bag HTS BOA Rail Frame in Standard Colors as shown **\$96,600.00**



## BOXING FRAME.

Whether for advanced combat classes or for beginner striking sessions, this modular frame works as a grid system and can be configured to hold a customized number of bags in fixed positions to meet the number of users, with the option to scale up or down in numbers easily. An efficient, space-saving solution and an adaptable option for all abilities.



### DIMENSIONS.



**FCD05515-01U** 12 Bag Boxing Frame Standard Colors Color as shown **\$22,954.00**  
**\$24,542.00**

# OPTIONAL FRAME ATTACHMENTS, MAXIMUM FUNCTIONALITY.



## CRUX ROPE PULLEY.

Constructed from a heavy-duty steel case and polypropylene rope, the CRUX was made to withstand the most challenging training sessions. This optional piece of kit is intuitive, beautifully designed, requires zero setup, and the adjustable resistance makes it suitable for all users.

Get to grips with the CRUX to elevate heart rate, build functional strength, and improve cardiovascular endurance.

### DESIGN.

The CRUX Rope Pulley is designed to fit seamlessly with the Octagon frame range.

### VARIABLE RESISTANCE.

No setup required. Simply select resistance level to get started.

### POLYPROPYLENE SYNTHETIC ROPE.

Durable enough to withstand heavy commercial use without breaking down.

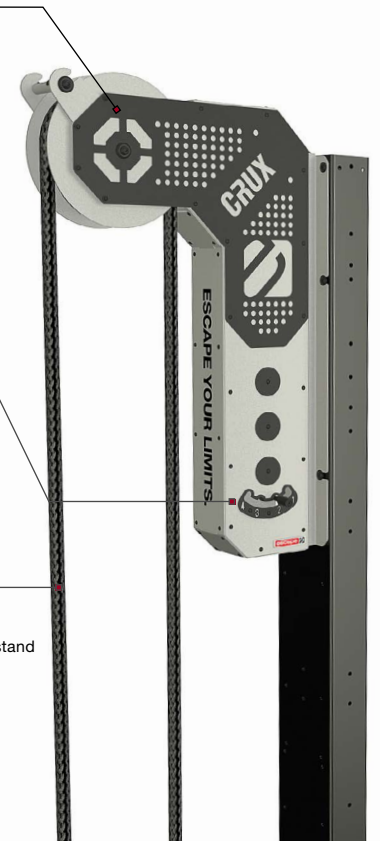

OCA093 CRUX Rope Pulley **\$3,850.00**

**PLEASE NOTE:** additional mount plates may be required, please speak to sales representative for more information.

**SPECIFICATIONS.**  
23.8" x 6.9" x 37.5".



## THE STACK.

The STACK is a solid steel cable column designed to sync perfectly with the Escape HIT HUB and Octagon training frames, adding versatility and dynamism to any workout.

Featuring a 300lb weight stack on a 2:1 cable ratio, the STACK offers a 160 degree cable range with a 9ft cable travel length. This engineering provides total freedom in terms of resistance and movement, delivering the ultimate in cable training for the everyday use.



**DESIGN.**  
Designed to fit seamlessly with the Octagon frame range.

**CABLE.**  
160° cable range with a 9ft cable travel length.

**HANDLE.**  
Track adjustable stirrup handle.

**WEIGHT.**  
300lb weight stack on a 2:1 cable ratio.

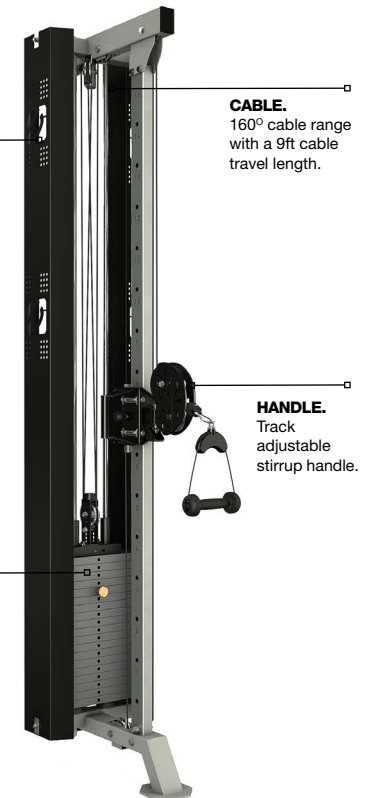

**OCA105** The STACK

\$6,500.00

**SPECIFICATIONS.**  
2' 7.3" x 1'.5" x 10'.7".



## BASE BENCH.

This lightweight pad supports the upper body whilst engaging muscles of the lower body to provide stability across a wide range of pushing and pulling exercises. This delivers a whole-body workout with every rep.

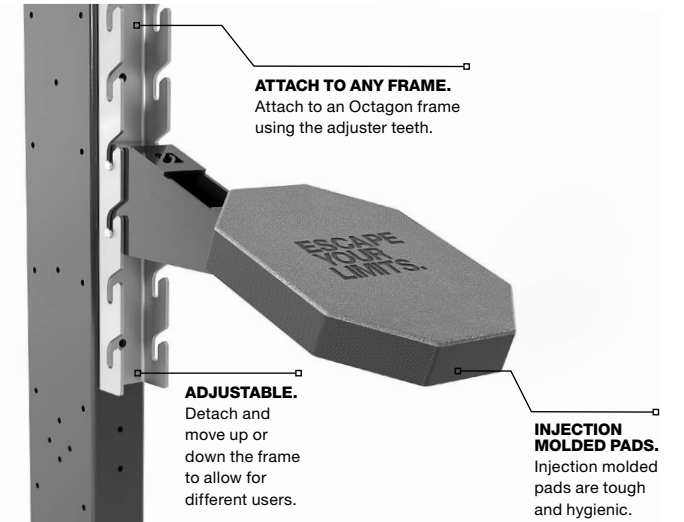

OCTAGON.

### EXERCISES.

The BASE BENCH is suitable for a range of exercises.



SEATED PRESS.



CHEST PRESS.



ROW.



SPLIT SQUAT.

OCA110 BASE BENCH

\$760.00

**SPECIFICATIONS.**  
12.5" x 27.9" x 9".

# DESIGNED TO ORDER.

## DESIGNED TO ORDER. INNOVATE, PREMIUM, STYLISH FRAMES.

In addition to our off-the-shelf frames, Octagon frames can be made bespoke, creating almost limitless opportunities for a frame unique to your brand or environment.

In 3 simple steps, our expertly trained designers will turn your dream frame into a functional reality.

Manufactured in the UK, handmade with skill and using only the most premium steel, we'll build you a frame that makes an impact and withstands the toughest of training settings.

### 3 SIMPLE STEPS TO MAKE YOUR DREAM FRAME A REALITY.

**01.**  
DESIGNING  
FOR IMPACT.

**02.**  
ADDING YOUR  
ATTACHMENTS.

**03.**  
CHOOSE YOUR  
COLOR.

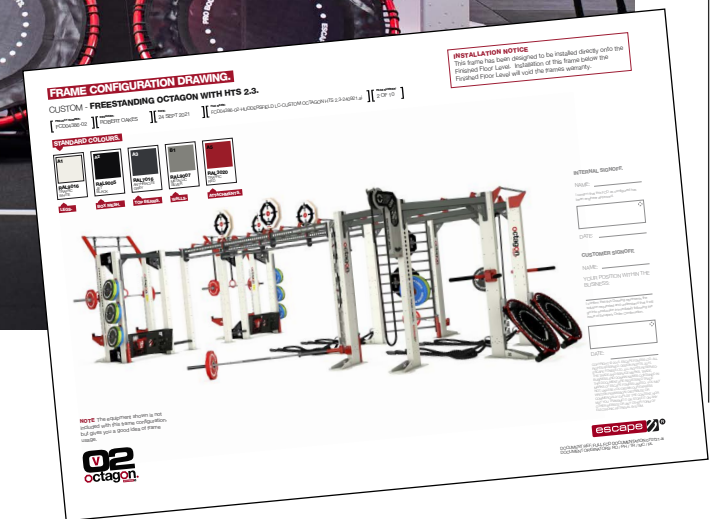
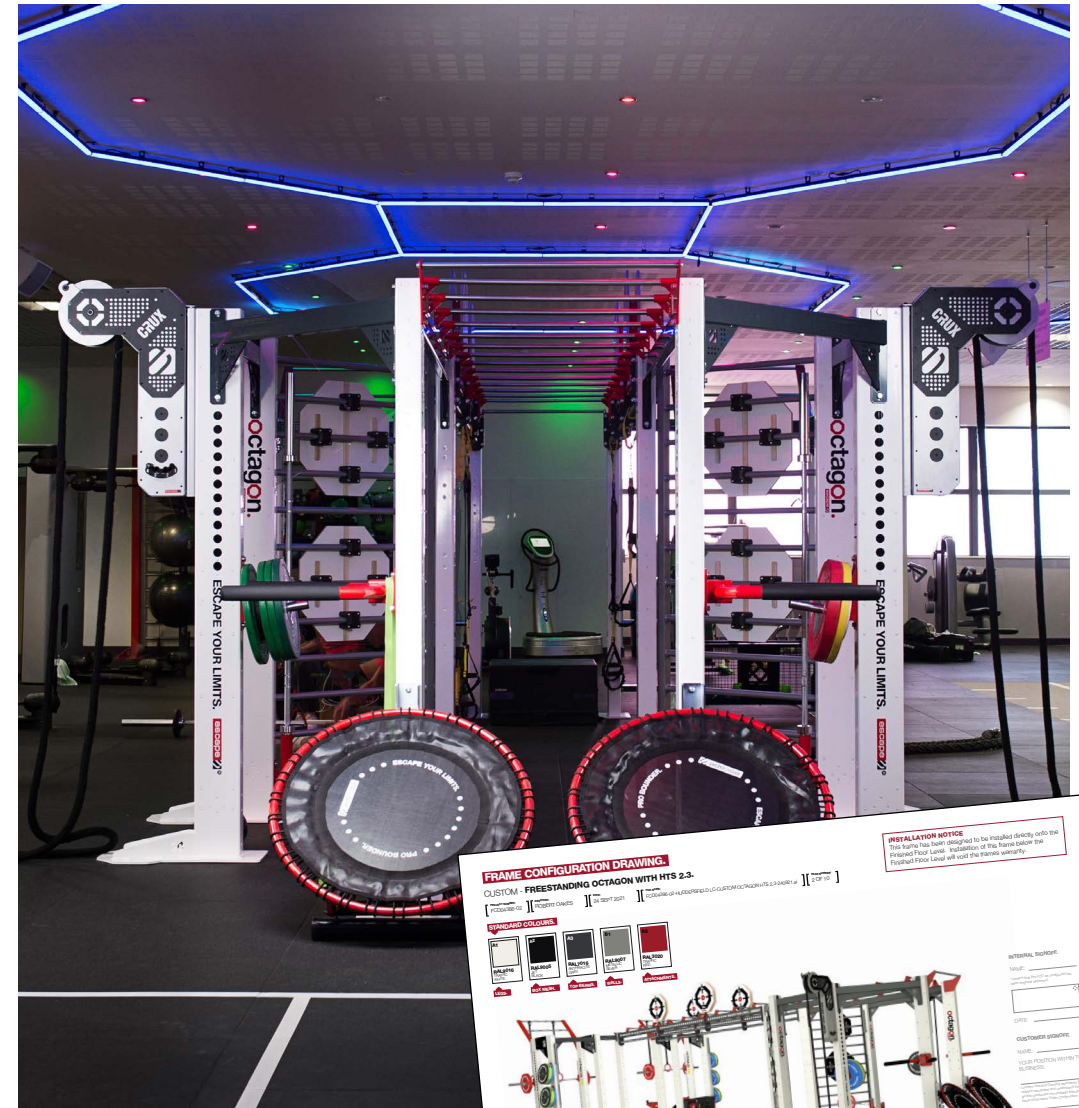

OCTAGON.



DESIGNED TO ORDER.

# 01. DESIGNING FOR IMPACT.

All of our design experts have at least two years' experience building the most impressive functional training frames built to fit your individual needs.

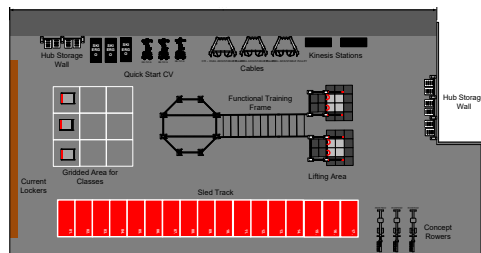

They will first help you plan your frame for maximum efficiency and effect, considering your floor space, desired training modalities and the environment.

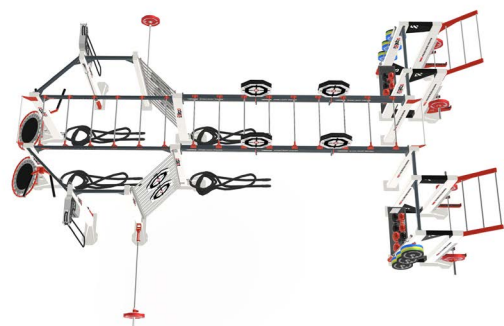

Alongside this, our team will ensure we build a frame that is safe and future proofed.

**OVER 25  
YEARS INDUSTRY  
EXPERIENCE.**

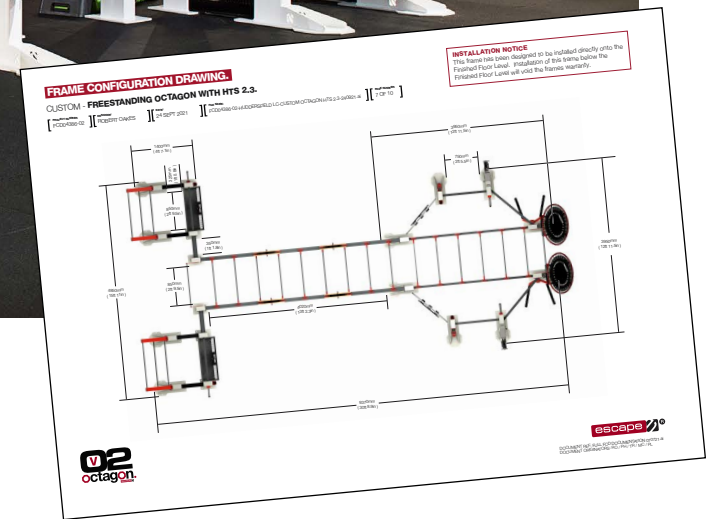
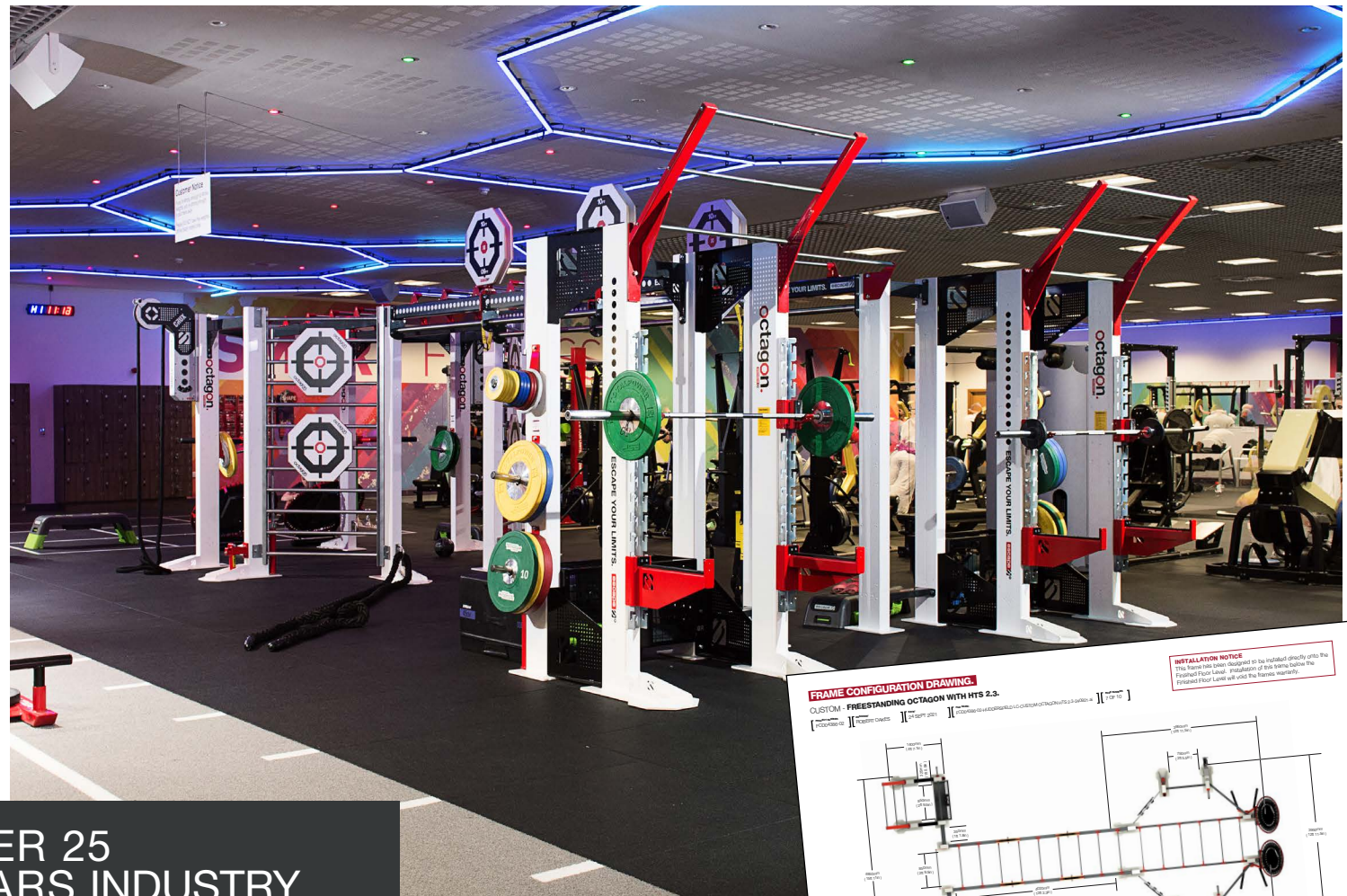

OCTAGON.

# DESIGNED TO ORDER.

## 02. CHOOSING YOUR ATTACHMENTS.

Escape offers a wide selection of optional attachments to maximize and individualize the functionality and versatility of your bespoke Octagon frame.

A small selection of accessories are shown opposite. These include the new CRUX ROPE - the ultimate infinity rope training, and the STACK, the frame-mounted cable column with adjustable resistance.

If your training space has a low ceiling, there is the option to select a shorter frame leg.

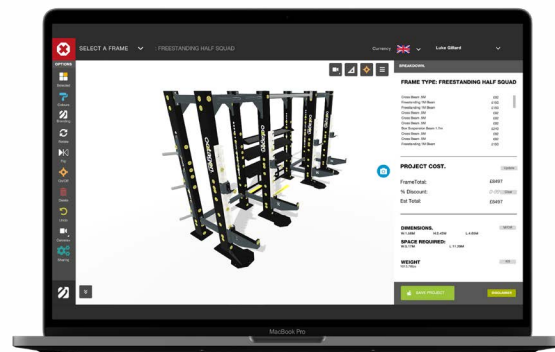

Through our app, you can try an array of options - adding various attachments until you design the ultimate frame for your requirements. If you need a little extra help, our team is always on hand to help.

Please contact us or your sales representative for the full range of accessories available.

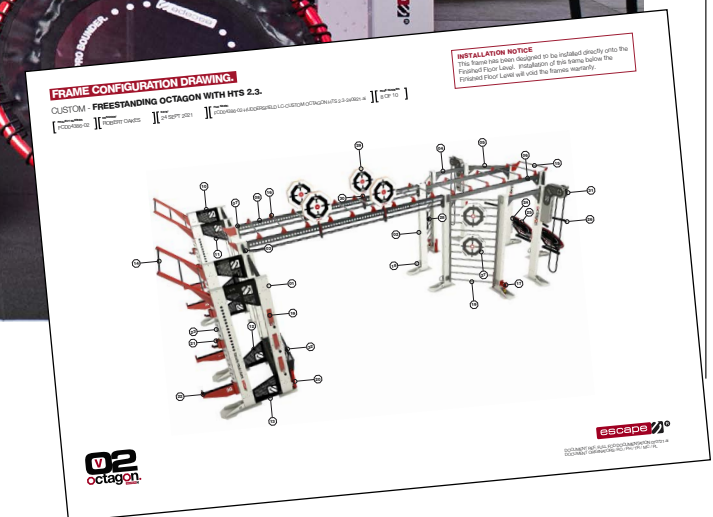
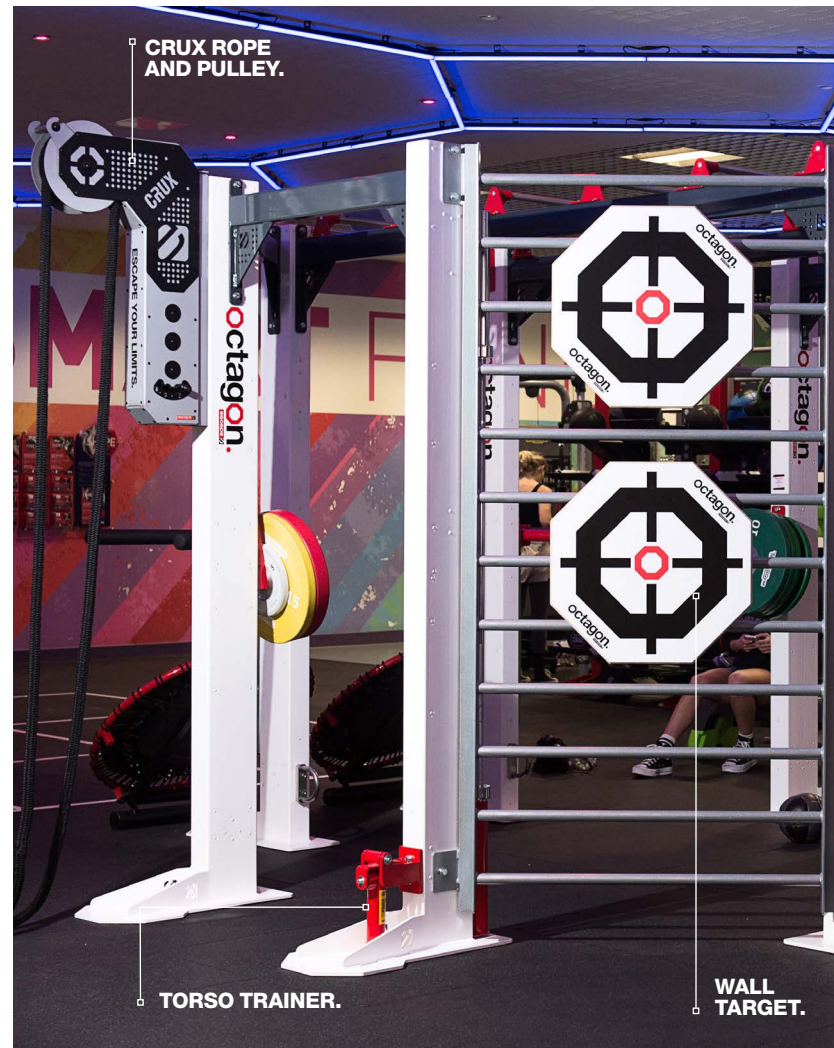

OCTAGON.

DESIGNED TO ORDER.

# 03. CHOOSING YOUR COLOR.

Create a frame that stands out or blends into the environment, its your choice with our color options.

Escape now offers an expanded range of color options, giving you the opportunity to create functional frames that match your unique club branding and environment.

Bring your frame to life with our range of standard, premium or bespoke colors.

## STANDARD COLORS.

**JET BLACK**  
RAL9005



**ANTHRACITE GRAY**  
RAL7016



## PREMIUM COLORS.

**TRAFFIC WHITE**  
RAL9016

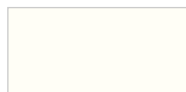

**METALLIC SILVER**  
RAL9007



**TRAFFIC RED**  
RAL3020



**TRAFFIC BLUE**  
RAL5017



**YELLOW GREEN**  
RAL6018



**RAPSEED YELLOW**  
RAL1021



**TRAFFIC ORANGE**  
RAL2009

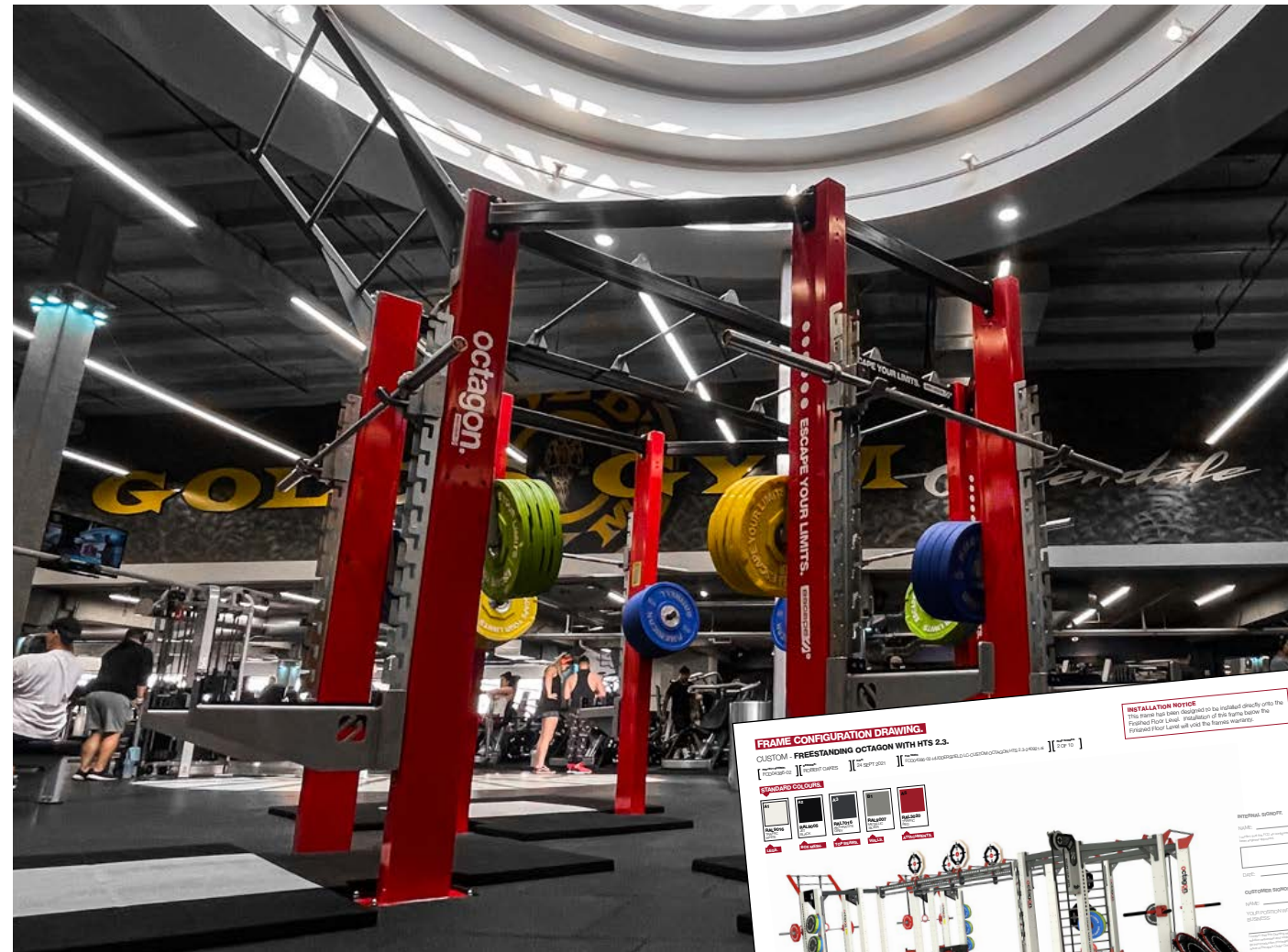

OCTAGON.

# FUNCTIONAL.

Working in multiple planes of motion strengthens and conditions the whole body, from knees and ankles to shoulders and hips. The Escape range of functional training equipment provides the ideal starting point for this style of training, but also offers a more of a challenging workout for those really who need it.



BARROW	102
TIYR	104
QUAD SLED	106
SPEED TRAINING	107
PLYO BOXES	108
TRAINING BAGS	112
MEDICINE BALLS	116
GRIPR	126
WOD RINGS	127
BATTLE ROPES	127
CMT	128
PRO BOUNDER	129
AMMO BOX	130
POWER BANDS	130
JUMP ROPES	131
RACK5 PRODUCT PACKS	132

# THE NEXT BIG THING IN FITNESS.



SCAN FOR MORE INFORMATION.

## BARROW.

Designed in partnership with Pete Holman, world renowned Strength Coach and Inventor of the TRX RipTrainer and Nautilus Glute Drive, The Escape Barrow is the only easy-load, back-safe and 'sexy as hell' machine that combines two essential exercise modalities; the loaded carry and the sled push.



**HANDLES.**  
Multiple grip handles allow users to position their hands for exercises such as farmer's carries and sled pushes.

**LOAD CAPACITY.**  
Impressive load capacity of 440lb.

**MATERIALS.**  
Carbon steel frame and two plate loading points.

**DURABILITY.**  
Galvanized for outdoor use and durability.

**BARROW1** BARROW **\$1,745.00**

**SPECIFICATIONS.**  
Size: 50.2" x 33.8" x 35.7". Weight: 137lb.

FUNCTIONAL.

# PRESS, JUMP, FLIP, LIFT AND PULL.



SCAN FOR MORE INFORMATION.

## THE TIYR.®

Made in the UK, the TIYR is soft yet very strong, simple but innovative. It's also super tough, just like the real thing.

### HANDLES.

The ultra tough CORDURA® handles can be used for lifting and carrying, and as attachment points for Battle Ropes.



### MATERIALS.

PVC cover with Clearguard lacquer finish and screen printed graphics over a reconstituted foam core.

### PATENTED.

<b>TIYR01</b>	90lb	TIYR - Green	<b>\$1,530.00</b>
<b>TIYR02</b>	130lb	TIYR - Blue	<b>\$1,915.00</b>
<b>TIYR03</b>	175lb	TIYR - Red	<b>\$2,160.00</b>
<b>TIYR04</b>	220lb	TIYR - Black	<b>\$2,585.00</b>
<b>TRAIN05</b>		TIYR - Product Training Workshop	<b>\$79.00</b>

### 90lb

**OUTSIDE DIAMETER:**  
34"

**INSIDE DIAMETER:**  
16"

**HEIGHT:**  
10"



### 130lb

**OUTSIDE DIAMETER:**  
41"

**INSIDE DIAMETER:**  
20"

**HEIGHT:**  
12"



### 175lb

**OUTSIDE DIAMETER:**  
47"

**INSIDE DIAMETER:**  
24"

**HEIGHT:**  
15"



### 220lb

**OUTSIDE DIAMETER:**  
47"

**INSIDE DIAMETER:**  
24"

**HEIGHT:**  
15"



FUNCTIONAL.

# QUAD SLED.™

A simple, brutal workout tool that builds core and leg power. Stylish and compact, our sled features two moveable drive posts which can be positioned at either end of the sled and the low drive bar increases the challenge.

**LOAD UP TO 330 LB.**  
heavy loading options on the sled is great for even the strongest athlete.

**ATTACH A BATTLE ROPE.**  
Front and back for a loaded heavy pull.

**RUNNERS.**  
Nylon runners for use on specialist Speed Tracks or sport carpet type flooring.

**QSLED** Quad Sled **\$920.00**

**SPECIFICATIONS.**  
Size: 38" x 29" x 39". Weight 88lb.

**Plates not included.**

# SPEED TRAINING.

Empower training potential realization. Incorporate our range of hard wearing, colorful, SAQ products into speed and agility sessions. Great for group work catering to all abilities.

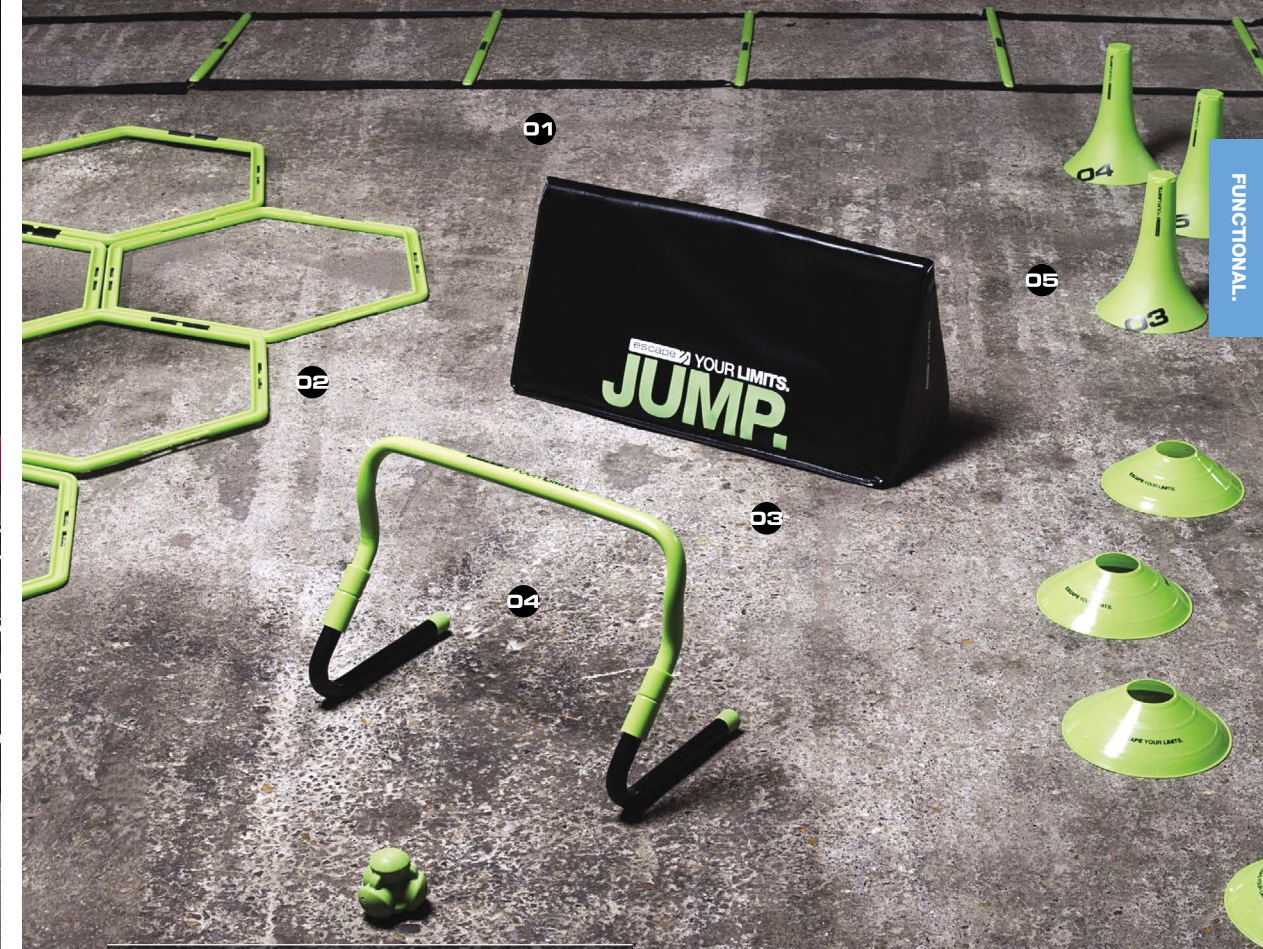

- 01. EST-SL** Speed Ladder  
Size: 124" x 20" **\$61.00**
- 02. EST-AGS** Agility Grid System – Set of 6  
Size: 20" x 23" **\$53.00**
- 03. EST-LEH** Lateral Endurance Hurdle – Each  
Size: 12" x 24" x 8". (Whilst stocks last) **\$85.00**
- 04. EST-AH** Adjustable Hurdle – Each  
Size: 6" x 12". **\$22.50**
- 05. EST-HC6** Speed Cones – Set of 6 **\$28.50**

FUNCTIONAL.

# PLYOSOFT BOX.

Take your training experience to a new level with plyometrics. Open up opportunities for stable box jump patterns in frontal, lateral and transverse planes. Adding to the challenge are target markings as part of the top surface design, giving users precise areas to aim for.

**PERFORMANCE.**  
Both top and bottom surfaces are made of anti-slip material for performance and stability.

**FILLING.**  
Made in the UK from light weight foam.

**DURABILITY.**  
For more durability, a tough outer material is tightly fitted over a firm foam filling.

**SECURE.**  
Patented velcro tabs so you can safely stack the boxes.

6" (Top view height)

12" (Side view height)

18" (Side view height)

24" (Side view height)

35" (Top view width)

**TARGET HOT SPOTS.**  
Users can land their hands or feet on targets on the top surface for an extra challenge.



**PATENTED.**

<b>CPLYOB05</b>	Plyosoft Box 6" – Gray	<b>\$365.50</b>
<b>CPLYOB1</b>	Plyosoft Box 12" – Green	<b>\$480.00</b>
<b>CPLYOB2</b>	Plyosoft Box 18" – Blue	<b>\$715.00</b>
<b>CPLYOB3</b>	Plyosoft Box 24" – Red	<b>\$810.00</b>
<b>CPLYS3</b>	Plyosoft Box Set of 3 (Green, Blue, Red)	<b>\$2,000.00</b>
<b>CPLYS4</b>	Plyosoft Box Set of 4 (Gray, Green, Blue, Red)	<b>\$2,360.00</b>

# MULTIPLYO®

We've taken the great idea of a 3-in-1 plyo box and given it the Escape treatment. Made to the same dimensions as the boxes used for cross training, this great space-saving box is the perfect tool to introduce beginners to plyometrics.

**LANDING ZONES.**  
Anti-slip landing zones are on all six sides, and it's designed so that it won't move when in use.

**COVER.**  
An easy-to-clean GTEX cover is securely heat welded over a foam core to avoid creasing.

**FILLING.**  
Made in the UK from light weight foam.

20" (Side view height)

30" (Side view width)

24" (Side view height)

20" (Side view width)

30" (Side view height)

24" (Side view width)

**PATENTED.**

<b>MULTIP2</b>	Multiplyo	<b>\$1,040.00</b>
----------------	-----------	-------------------

**SPECIFICATIONS.**  
Size: 20" x 30" x 24"

FUNCTIONAL.



# PLYOSOFT BOX® BLACK.

These soft plyometric boxes can be used individually or stacked for variable height options depending on ability and progress. The Patented velcro tabs hold them in place for safety and confidence when stacking, and they're light weight, so they're easy to move while in use or for storage.

**SECURE.**  
Patented velcro tabs so you can safely stack the boxes.

**COVERING.**  
Durable PVC covering.



**FILLING.**  
Made in the UK from High-density foam filling.

**DESIGN.**  
Classic design and usability allows users to get back to the fundamentals and concentrate on what matters – performance.

**PATENTED.**

**BLPLYS1** Set of 3 Black Plyoboxes **\$1,240.00**

**SPECIFICATIONS.**  
Sizes: 01: 12". 02: 18". 03: 24".



FUNCTIONAL.



SCAN FOR MORE INFORMATION.



SCAN FOR MORE INFORMATION.

## FITNESS BULGARIAN BAG.®

Bright colors, a range of weight options and a huge selection of different applications – the Fitness Bulgarian Bag should feature in every serious functional training zone.

### WEIGHT RANGE.

High quality, hand-made in Bulgaria, the Fitness Bulgarian Bag comes in bright colors and weight options suitable for every functional training zone.



### GRIP.

The handles, grips and straps mean the bag can be used for a range of different exercises.

### COATING.

The Fitness Bulgarian Bag has a synthetic leather coating, making it easy to wipe down and keep clean.

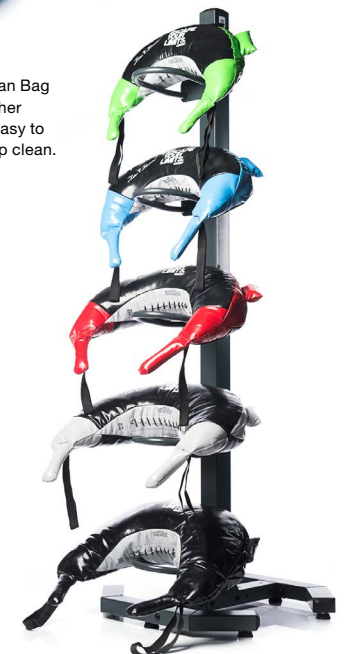

<b>FVBBAG5V3</b>	12lb	Fitness Bulgarian Bag – Green	<b>\$245.00</b>
<b>FVBBAG8V3</b>	17lb	Fitness Bulgarian Bag – Blue	<b>\$256.00</b>
<b>FVBBAG12V3</b>	26lb	Fitness Bulgarian Bag – Red	<b>\$267.00</b>
<b>FVBBAG17V3</b>	37lb	Fitness Bulgarian Bag – Gray	<b>\$278.00</b>
<b>FVBBAG22V3</b>	50lb	Fitness Bulgarian Bag – Black	<b>\$300.00</b>
<b>TRAIN02</b>		Bulgarian Bag - Product Training Workshop	<b>\$79.00</b>

### RACK SPECIFICATIONS.

<b>RACKM5</b>	5 Shelf Rigid Multi Rack – Holds 5 bags	<b>\$485.00</b>
	Size: 27.5" x 27.5" x 82". Max load 65lb. Weight 68lb (as shown)	
<b>RACKM10</b>	10 Shelf Rigid Multi Rack – Holds 10 bags	<b>\$625.00</b>
	Size: 27.5" x 27.5" x 82". Max load 310lb. Weight 89lb.	
<b>RACK5</b>	RACK5 – Holds 10 bags	<b>\$1,285.00</b>
	Size: 23.5" x 27.5" x 73". Weight 165lb.	

**Bulgarian Bags sold separately.**

FUNCTIONAL.



## COREBAG®

This fitness space staple makes functional training even more accessible for beginners or veterans alike. Deadlift, pull, press, swing and perform many other movements in comfort through great ergonomics and practical weight progression.

### REGISTERED DESIGN.

<b>ECB050V3</b>	11lb	Corebag – Green	<b>\$108.00</b>
<b>ECB100V3</b>	22lb	Corebag – Blue	<b>\$115.00</b>
<b>ECB150V3</b>	33lb	Corebag – Red	<b>\$122.00</b>
<b>ECB200V3</b>	44lb	Corebag – Gray	<b>\$130.00</b>
<b>ECB250V3</b>	55lb	Corebag – Black	<b>\$140.00</b>

**TRAIN08** Corebag Product Training Workshop **\$79.00**

### RACK SPECIFICATIONS.

<b>RACKM5</b>	5 Shelf Rigid Multi Rack – Holds 5 bags	<b>\$485.00</b>
	Size: 27.5" x 27.5" x 82". Max load 65lb. Weight 68lb	
<b>RACKM10</b>	10 Shelf Rigid Multi Rack – Holds 10 bags	<b>\$625.00</b>
	Size: 27.5" x 27.5" x 82". Max load 310lb. Weight 89lb.	
<b>RACK5</b>	RACK5 – Holds 10 bags	<b>\$1,285.00</b>
	Size: 23.5" x 27.5" x 73". Weight 165lb.	

Corebags sold separately.



## MULTI RACK.

Minimal footprint but maximum impact, our Multi Rack stores functional training bags vertically to retain as much workout space as possible, whilst ensuring a safe training space. Available in two options, a single sided 5 shelf (as shown) or double sided 10 shelf rack.



SCAN FOR MORE INFORMATION.

TURN TO PAGE 187 FOR WARRANTIES

# MEDICINE BALLS.

There are different sizes, weights and textures across the range – and specialist features such as the VERTMINI's compact size and the Multi Grip Medball's integrated handles.



## COMPARISON CHART.

FEATURES.	ENDURA BALL.	VERTBALL.	VERTMINI.	TOTAL GRIP.	MULTI GRIP.	SLAMBALL SBX.
USE	Personal training, general use	Cross training, PT zones	Team games, mobility and functional spaces	General PT and functional training where grip is key	Vigorous workouts, building core strength, rotational power	Functional zones, cross training, sports performance
WEIGHTS	4lb 6lb 8lb 10lb 12lb 14lb 16lb 18lb 20lb 25lb 30lbs	6.6lb - Green 8.8lb - Blue 11lb - Red 13.2lb - Gray 15.4lb - Black 17.6lb - Green 19.8lb - Blue 22lb - Red	2.2lb - Green 4.4lb - Blue 6.6lb - Red 8.8lb - Gray 11lb - Black	2lb 4lb 6lb 8lb 10lb	12lb 14lb 16lb 18lb 20lb	11lb - Green 22lb - Blue 33lb - Red 44lb - Gray
DIAMETER	14"	14"	8"	9.5"	9"	10"
FEATURE	Abrasion resistant extra grip textured surface	Oversized design to correct postural alignment	Sure-grip, soft surface ideal for throwing and rolling	Extra grip textured surface	Integrated handles for more movement options	Hardcore and durable for extreme training
WARRANTY	1 year	1 year	1 year	1 year	1 year	1 year

# HOW TO CHOOSE.



## ENDURA BALL.

Tough, durable and versatile. This is the ultimate soft, multi-purpose, medball. Slam it, lift it, chuck it. This ball will withstand high levels of training punishment.



## VERTBALL™.

Designed to be caught and thrown at speed. Perfect for high velocity training. Throw it at a wall. Throw it to a partner. Throw it on the floor. Just throw it.



## VERTMINI™.

An evolution of the classic VERTBALL. Small and soft, perfect for partner-games training and dynamic movements. Bright, attractive design.

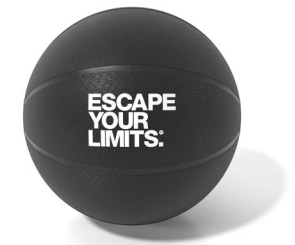

## TOTAL GRIP MEDBALL.

A fundamental of functional fitness, this classic rubber medball has a textured surface for a firm grip.



## MULTI GRIP MEDBALL.

A practical twist on the classic medball. Integrated 'handles' add a new dynamic that supports even more movement options.



## SLAMBALL SBX™.

Hardcore, rubber medball, designed for extreme training. This is the most durable, classic design medball in the Escape range.

FUNCTIONAL.



# ENDURA BALL.

These are the toughest medicine balls in the Escape range, and double up as a great 2 in 1 slamball or medicine ball option. Designed for a variety of workouts that will push anyone to reach a new level of fitness.

**MATERIAL.**

A combination of synthetic polyester wool, rubber crush and cork make for robustness you can trust.



**DURABILITY.**

The hardwearing material of the ENDURA Ball makes it the ideal tool for heavy duty usage.

**NUMBERING.**

Oversized numbering stitched in makes for quick and easy weight identification.

FUNCTIONAL.



<b>AENDUR204</b>	4lb	ENDURA Ball	<b>\$163.00</b>
<b>AENDUR206</b>	6lb	ENDURA Ball	<b>\$167.50</b>
<b>AENDUR208</b>	8lb	ENDURA Ball	<b>\$172.00</b>
<b>AENDUR210</b>	10lb	ENDURA Ball	<b>\$176.50</b>
<b>AENDUR212</b>	12lb	ENDURA Ball	<b>\$181.00</b>
<b>AENDUR214</b>	14lb	ENDURA Ball	<b>\$185.50</b>
<b>AENDUR216</b>	16lb	ENDURA Ball	<b>\$190.00</b>
<b>AENDUR218</b>	18lb	ENDURA Ball	<b>\$194.50</b>
<b>AENDUR220</b>	20lb	ENDURA Ball	<b>\$199.00</b>
<b>AENDUR225</b>	25lb	ENDURA Ball	<b>\$207.50</b>
<b>AENDUR230</b>	30lb	ENDURA Ball	<b>\$216.00</b>

**TRAIN04** Medicine Balls Product Training Workshop **\$79.00**

**RACK SPECIFICATIONS.**

<b>RACKM5</b>	5 Shelf Rigid Multi Rack – Holds 5 balls Size: 27.5" x 27.5" x 82". (as shown) Max load 65lb. Weight 68lb	<b>\$485.00</b>
<b>RACKM10</b>	10 Shelf Rigid Multi Rack – Holds 10 balls Size: 27.5" x 27.5" x 82". Max load 310lb. Weight 89lb.	<b>\$625.00</b>
<b>RACKS</b>	RACK5 Size: 23.5" x 27.5" x 73". Weight 165lb.	<b>\$1,285.00</b>

**ENDURA Balls sold separately.**

# VERTBALL.™

The VERTBALL has been specifically designed for throwing – to a partner or against a wall. Because it's oversized it works muscles from the feet right up to the hands, and develops coordination, balance, acceleration and deceleration.



**MATERIALS.**  
Outer material is synthetic leather with rubber granule filling to ensure ball does not break down over time.

**COLORS.**  
Vibrant colors for instant appeal.

**STITCHING.**  
Soft outer skin is constructed from 26 individually stitched leather panels to ensure the ball maintains its shape and flies straight.

**LARGER SIZE.**  
The oversized design (diameter of 14") encourages correct posture, keeping the core engaged.

**WHILST STOCKS LAST.**

<b>VERT03</b>	6.6lb	VERTBALL – Green	<b>\$75.00</b>
<b>VERT04</b>	8.8lb	VERTBALL – Blue	<b>\$79.50</b>
<b>VERT05</b>	11lb	VERTBALL – Red	<b>\$84.00</b>
<b>VERT06</b>	13.2lb	VERTBALL – Gray	<b>\$88.50</b>
<b>VERT07</b>	15.4lb	VERTBALL – Black	<b>\$93.00</b>
<b>VERT08</b>	17.6lb	VERTBALL – Green	<b>\$97.50</b>
<b>VERT09</b>	19.8lb	VERTBALL – Blue	<b>\$102.00</b>
<b>VERT10</b>	22lb	VERTBALL – Red	<b>\$106.50</b>
<b>TRAIN04</b>	Medicine Balls Product Training Workshop		<b>\$79.00</b>

**RACK SPECIFICATIONS.**

<b>RACKM5</b>	5 Shelf Rigid Multi Rack – Holds 5 balls	<b>\$485.00</b>
	Size: 27.5" x 27.5" x 82". (as shown)	
	Max load 65lb. Weight 68lb	
<b>RACKM10</b>	10 Shelf Rigid Multi Rack – Holds 10 balls	<b>\$625.00</b>
	Size: 27.5" x 27.5" x 82".	
	Max load 310lb. Weight 89lb.	
<b>RACK5</b>	RACK5 – Holds 5 balls	<b>\$1,285.00</b>
	Size: 23.5" x 27.5" x 73". Weight 165lb.	

VERTBALLs sold separately.



# VERTMINI.™

The VERTMINI is the ideal tool for getting into medball workouts, with compact sizes that make it perfect for partner exercises and mobility workouts. As well as its smaller size, an outer surface that's softer than your average medball means that users of all abilities will quickly feel confident with the VERTMINI.



**INNER FILLING.**  
Cork granules, synthetic wool, treated pebbles.

**OUTER COVER.**  
Sure grip artificial leather with polyester lining laminated with natural liquid rubber.

**COLORS.**  
Vibrant colors for instant appeal.

**SMALLER SIZE.**  
The smaller sized VERTMINIs (8" diameter) are ideal for kids functional fitness, and can be used one-handed by adults.

<b>EVM01</b>	2.2lbs	VERTMINI - Green	<b>\$38.00</b>
<b>EVM02</b>	4.4lbs	VERTMINI - Blue	<b>\$45.50</b>
<b>EVM03</b>	6.6lbs	VERTMINI - Red	<b>\$53.00</b>
<b>EVM04</b>	8.8lbs	VERTMINI - Gray	<b>\$59.50</b>
<b>EVM05</b>	11lbs	VERTMINI - Black	<b>\$66.00</b>
<b>TRAIN04</b>	Medicine Balls Product Training Workshop		<b>\$79.00</b>

**RACK SPECIFICATIONS.**

<b>RACKM5</b>	5 Shelf Rigid Multi Rack – Holds 5 balls	<b>\$485.00</b>
	Size: 27.5" x 27.5" x 82".	
	Max load 65lb. Weight 68lb	
<b>RACKM10</b>	10 Shelf Rigid Multi Rack – Holds 10 balls	<b>\$625.00</b>
	Size: 27.5" x 27.5" x 82".	
	Max load 310lb. Weight 89lb.	
<b>RACK5</b>	RACK5 – Holds 20 balls (as shown)	<b>\$1,285.00</b>
	Size: 23.5" x 27.5" x 73". Weight 165lb. (as shown)	

VERTMINIs sold separately.



FUNCTIONAL.

# TOTAL GRIP MEDBALL.

If you're after the fundamentals of functional fitness, look no further than this range of rubber medballs to focus on the foundational movements to build strength, power, agility and speed.

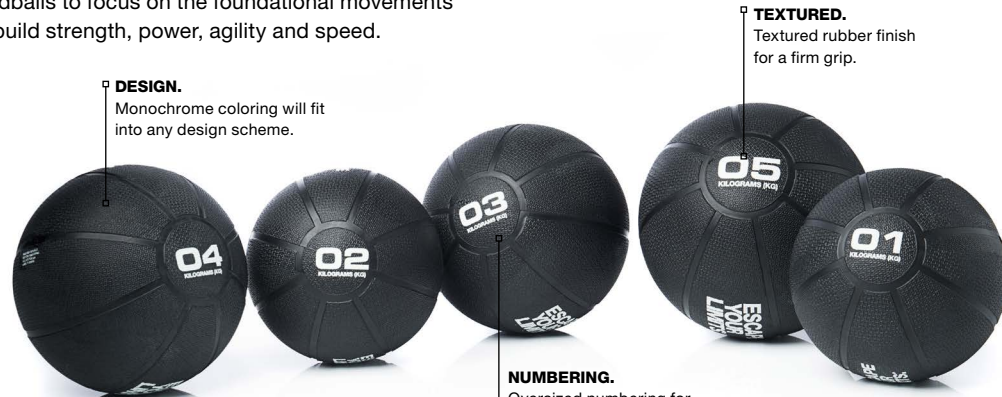

**DESIGN.**  
Monochrome coloring will fit into any design scheme.

**TEXTURED.**  
Textured rubber finish for a firm grip.

**NUMBERING.**  
Oversized numbering for fast weight identification.

<b>ATGMED02</b>	2lb	Total Grip Medball	<b>\$31.00</b>
<b>ATGMED04</b>	4lb	Total Grip Medball	<b>\$39.50</b>
<b>ATGMED06</b>	6lb	Total Grip Medball	<b>\$48.00</b>
<b>ATGMED08</b>	8lb	Total Grip Medball	<b>\$56.50</b>
<b>ATGMED10</b>	10lb	Total Grip Medball	<b>\$65.00</b>
<b>TRAIN04</b>	Medicine Balls Product Training Workshop		<b>\$79.00</b>

# MULTI GRIP MEDBALL.

Benefit from increased stability and even more workout options thanks to integrated ergonomic grip handles, offering a practical twist on the classic medball design for one or two hand holds.



**MATERIAL.**  
Made from textured rubber and designed to bounce.

**NUMBERING.**  
Oversized numbering for fast weight identification.

**HANDLES.**  
The ergonomic handles mean that each ball can be comfortably used with one or two hands.

**GRIP STRENGTH.**  
Increased forearm strength and grip improvements both result from double grip medball training.

<b>AMGMED12</b>	12lb	Multi Grip Medball	<b>\$106.00</b>
<b>AMGMED14</b>	14lb	Multi Grip Medball	<b>\$116.00</b>
<b>AMGMED16</b>	16lb	Multi Grip Medball	<b>\$126.00</b>
<b>AMGMED18</b>	18lb	Multi Grip Medball	<b>\$136.00</b>
<b>AMGMED20</b>	20lb	Multi Grip Medball	<b>\$146.00</b>
<b>TRAIN04</b>	Medicine Balls Product Training Workshop		<b>\$79.00</b>

# MULTI RACK.

Designed so that you don't have to sacrifice precious floor space for storage, our Multi Rack, in a single sided 5 or double sided 10 rack option, will utilise vertical space to safely store functional training balls off the gym or studio floor.



**RACK SPECIFICATIONS.**

<b>RACKM5</b>	5 Shelf Rigid Multi Rack – Holds 5 balls	<b>\$485.00</b>
	Size: 27.5" x 27.5" x 82". Max load 65lb. Weight 68lb	
<b>RACKM10</b>	10 Shelf Rigid Multi Rack – Holds 10 balls	<b>\$625.00</b>
	Size: 27.5" x 27.5" x 82". Max load 310lb. Weight 89lb. (as shown)	
<b>RACK5</b>	RACK5 – Holds 20 balls	<b>\$1,285.00</b>
	Size: 23.5" x 27.5" x 73". Weight 165lb.	

Medicine Balls sold separately.

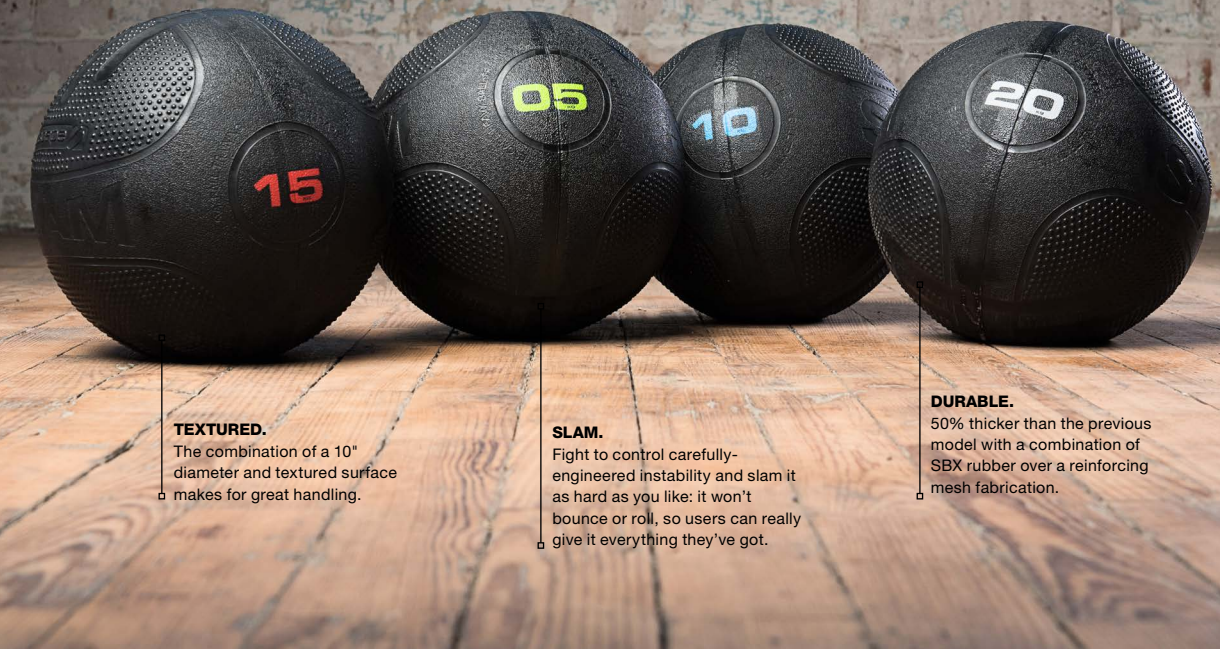

**TEXTURED.**

The combination of a 10" diameter and textured surface makes for great handling.

**SLAM.**

Fight to control carefully-engineered instability and slam it as hard as you like: it won't bounce or roll, so users can really give it everything they've got.

**DURABLE.**

50% thicker than the previous model with a combination of SBX rubber over a reinforcing mesh fabrication.

## SLAMBALL SBX.™

The SBX Slamball has had a makeover and is now tougher than ever. The new Slamball SBX delivers even more durability, so it's perfect for heavy use in workouts to build maximum power and core strength.

<b>SBSBX05</b>	11lb Slamball SBX – Green	<b>\$60.50</b>
<b>SBSBX10</b>	22lb Slamball SBX – Blue	<b>\$103.00</b>
<b>SBSBX15</b>	33lb Slamball SBX – Red	<b>\$145.00</b>
<b>SBSBX20</b>	44lb Slamball SBX – Gray	<b>\$187.50</b>

<b>TRAIN04</b>	Medicine Balls Product Training Workshop	<b>\$79.00</b>
----------------	------------------------------------------	----------------

**RACK SPECIFICATIONS.**

<b>RACKM5</b>	5 Shelf Multi Rack – Holds 5 balls Size: 27.5" x 27.5" x 82". Max load 65lb. Weight 68lb. (as shown)	<b>\$485.00</b>
<b>RACKM10</b>	10 Shelf Multi Rack – Holds 10 balls Size: 27.5" x 27.5" x 82". Max load 310lb. Weight 89lb.	<b>\$625.00</b>
<b>RACK5</b>	RACK5 – Holds 20 Balls Size: 23.5" x 27.5" x 73". Weight 165lb.	<b>\$1,285.00</b>

Slamball SBX sold separately.



## CORNER STORAGE.

Utilise awkward, underused corner space to efficiently and effectively store functional training equipment with our long-lasting, space-saving storage solutions that keep the training floor free of hazards, keeping equipment primed and ready for the next session.



FUNCTIONAL.

**RACK SPECIFICATIONS.**

<b>LLAS4</b>	Low Level 4 Shelf Angled Storage Size: 70" x 22" x 58". Weight 209.4lb. (as shown)	<b>\$2,390.00</b>
<b>ULLAS2</b>	Ultra Low Level 2 Shelf Angled Storage Size: 56" x 22" x 30". Weight 97.4lb.	<b>\$1,180.00</b>



# GRIPR.®

The GRIPR is made to withstand the toughest of treatment by using micro-grade steel sand within a fully-sealed, double-stitched neoprene bag to prevent leakage. This means it's perfect for dynamic exercises, and as an effective alternative to a medball, dumbbell or kettlebell.

**REGISTERED DESIGN.**



**DOUBLE STITCHED.**  
Fully-sealed, double-stitched neoprene bag to prevent leakage.

**NUMBERING.**  
Oversized numbering for fast weight identification.

**DURABLE.**  
Built to withstand the toughest dynamic exercises.

<b>GRIPR202</b>	4.4lb	GRIPR – Green	<b>\$50.50</b>
<b>GRIPR204</b>	8.8lb	GRIPR – Blue	<b>\$66.50</b>
<b>GRIPR206</b>	13.2lb	GRIPR – Red	<b>\$82.50</b>
<b>GRIPR208</b>	17.6lb	GRIPR – Gray	<b>\$98.50</b>
<b>GRIPR210</b>	22lb	GRIPR – White	<b>\$114.50</b>
<b>GRIPR212</b>	26.5lb	GRIPR – Green	<b>\$130.50</b>
<b>TRAIN06</b>	GRIPR Product Training Workshop		<b>\$79.00</b>
<b>AMB001</b>	Ammo Box Storage Size: 23.5" x 33" x 24". Maximum load 330lb. (see page 130)		<b>\$840.00</b>

# WOD RINGS.

The perfect addition to any Escape Octagon frame, these gymnastic rings enable a range of exercises for all abilities.



**STRAPS.**  
Strong hard wearing Nylon straps.

**RINGS.**  
Hard wearing moulded, textured plastic.

**HEIGHT ADJUSTMENT.**  
Unique numbered height adjustment anchor system.

**ADD TO A FRAME.**  
Aluminium carabiners that can be fitted to any Octagon frame.

<b>WODRING1</b>	WOD Ring (pair)	<b>\$145.00</b>
<b>SPECIFICATION.</b>		
Size: Overall: 87.9" x 9.25" Ring: 9.25" (OD), 1.1" (DIA)		
Strap: 78.7" (L) x 1.5" (W) x 0.05" (D)		

# BATTLE ROPES.

Battle Rope training is one of the most underutilized exercises in fitness training. It's a tough challenge that raises the heart rate, and develops core, forearm and grip strength. Made in the UK, our ropes are built to last, with the durability to withstand the highest intensity usage.



<b>BR3210</b>	33' x 1 1/4" Battle Rope	<b>\$330.00</b>
<b>TRAIN01</b>	Battle Rope Product Training Workshop	<b>\$79.00</b>
<b>SPECIFICATIONS.</b>		
Size: 33' length. 1.25" dia. Weight 11lb.		

FUNCTIONAL.

# CMT™

The Core Momentum Trainer™, or CMT, is transforming the way people train and target the core. It's about developing deep core muscles that are difficult to reach with standard training methods. The lubricated Power Shot inside the CMT collides with the Power Core walls, and controlling this force is what kick-starts the core muscles into action.



**ERGONOMICALLY DESIGNED.**

Textured surface makes it easier to grip.

**POWER SHOT.**

The lubricated Power Shot delivers a significant force.

**AUDIBLE FEEDBACK.**  
Combines sound with movement.

**REMOVABLE HANDLES.**  
Create even more workout options.

**PATENTED.**

<b>CMT1</b>	2.2lb	Core Momentum Trainer – Green	<b>\$155.00</b>
<b>CMT2</b>	4.4lb	Core Momentum Trainer – Blue	<b>\$185.00</b>
<b>CMT4</b>	8.8lb	Core Momentum Trainer – Red	<b>\$210.00</b>
<b>TRAIN11</b>	CMT - Product Training Workshop		<b>\$79.00</b>

Weight refers to the internal Power Shot.

# PRO BOUNDER™

Specially manufactured for commercial use, the PRO BOUNDER is safe, strong and fun. It features rubber bungees in place of steel springs for a safer, smoother rebounding experience. Light enough to move around the club, but durable enough to meet the demands of a busy gym, the PRO BOUNDER adds bounce to any workout.

**FRAME.**

The frame of the PRO BOUNDER is an extremely strong steel tube, light enough to carry around but sturdy enough for even the most aggressive rebounding.



**BUNGEEES.**

Bungees provide a smoother bounce than springs and are safer for users if they get hands or feet caught within the cords.

**FEET.**

Rubber bumpers act as 'feet' on the legs to ensure it does not move during fast-paced workouts.

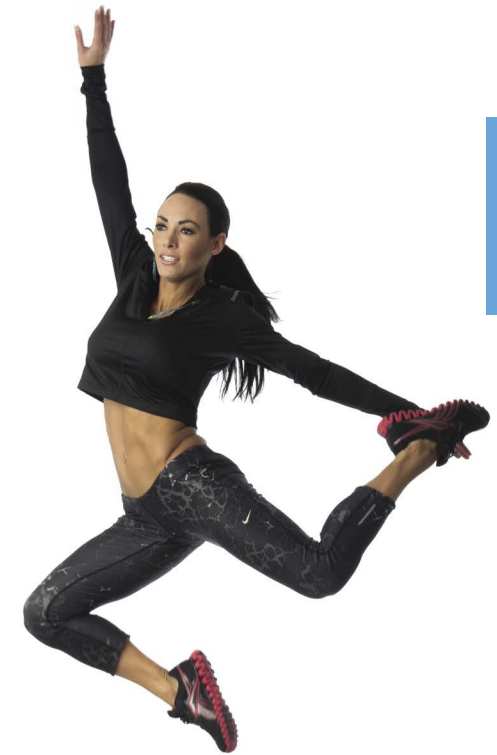

FUNCTIONAL.

**WHILST STOCKS LAST.**

**EST-REBOU** PRO BOUNDER **\$284.00**

**SPECIFICATION.**

Size: 45.75" x 12.25".



# AMMO BOX.

Perfect storage for small training equipment like boxing gloves, GRIPRs and power bands. The Ammo box is a stylish storage solution with ample capacity for most clubs.



**MATERIALS.**  
Made from 95% carbon steel, the Ammo Box is built to take a lot of abuse in busy gyms.

**SECURE.**  
Holes for padlock so you can keep your equipment safe.

**SOFT CLOSE LID.**  
Features include gas struts for a soft-close lid.

**EASY MOVEMENT.**  
The front handle and wheels make it easy to move to where people are working out.

**VENTILATION.**  
to help complete the drying of equipment between workouts

**REGISTERED DESIGN.**

**AMB001** Ammo Box Storage **\$840.00**

**SPECIFICATION.**

Size: 23.5" x 33" x 24". Maximum load 330lb.  
Equipment sold separately.

# POWER BANDS.

Looking for a little help to get you started with bodyweight training? Power Bands can support members when performing pull-ups and ab rollouts, and add resistance to squats and other exercises.



<b>WBANDS</b>	Power Band 01 – Green	<b>\$27.00</b>
<b>WBANDM</b>	Power Band 02 – Blue	<b>\$41.00</b>
<b>WBANDL</b>	Power Band 03 – Red	<b>\$55.00</b>

**SPECIFICATIONS.**

**WBANDS:** Width 1". Length 40". Resistance 24lbs-80lbs.  
**WBANDM:** Width 1.75". Length 40". Resistance 50lbs-120lbs.  
**WBANDL:** Width 2.5". Length 40". Resistance 60lbs-150lbs.

# FITNESS JUMP ROPE.

The ideal rope for introducing members to jump rope training. This rope is also up to the task of giving more advanced users a tool to improve coordination and raise their heart rate.



**EST-ROPE5** Fitness Jump Rope - Length 114" **\$28.00**

# CROSS TRAINING JUMP ROPE.

High jumping meets high performance. The ideal rope for serious cross training fans to perfect double-unders due to its roller-bearing handles and ultra-lightweight rope.



**EST-ROPE3** Cross Training Jump Rope - Length 116" **\$38.00**

FUNCTIONAL.

# RACK5.™

The RACK5 will keep your functional equipment in peak condition and your facility tidy, with plenty of options to adapt the shelves and rear storage to suit your needs.

**ADJUSTABLE HEIGHT.**  
Shelves can be arranged to suit the unique needs of gyms and studios.

**MATERIAL.**  
The RACK5 is made from strong carbon steel for inherent strength, and painted with a powder coat for a scratch-resistant finish.

**SHELVING.**  
Adjustable storage shelves for a range of functional kit.



**REGISTERED PATENT.**

<b>RACK5</b>	RACK5	<b>\$1,285.00</b>
<b>01. HOOPB15</b>	Rack5 Gym Ball Holder	<b>\$151.00</b>
<b>02. RACK5B5</b>	Rack5 Mat Rack Attachment	<b>\$62.00</b>

**SPECIFICATIONS.**  
**RACK5:** Size: 23.5" x 27.5" x 73". Weight 165lb.

**PLEASE NOTE:** Additional storage can be ordered separately.



# SHELVING.

RACK5 features integrated adjustable storage shelves for a range of functional kit. These pictures illustrate how equipment is stored on the various configurations.

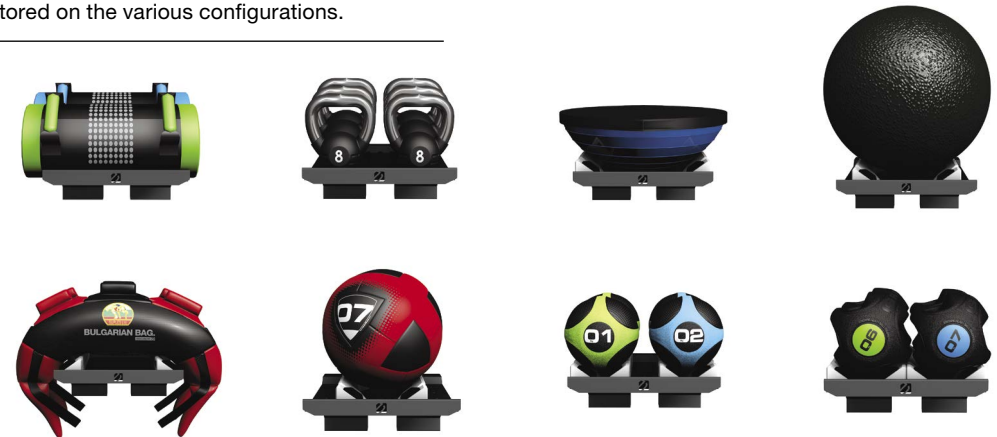

# RACK5 PACKS.

To save you time configuring your own equipment selection, we've assessed the demands of a functional and fitness focused workout based on our expertise, and have configured a specialized selection pack for both; Fitness or Functional, which incorporates our most popular items to specifically suit both these training needs.

<b>ARACK5EPFU RACK5 Functional Pack</b>	<b>\$3,080.00</b>
Pack includes:	
<ul style="list-style-type: none"> <li>RACK5</li> <li>3 x Ridge Rollers</li> <li>2 x 2lb and 4lb Total Grip Medballs</li> </ul>	<ul style="list-style-type: none"> <li>2lb, 4lb and 8.8lb CMTs</li> <li>11lb and 22lb Corebags</li> <li>2 x 16lb, 24lb and 32lb Studio Kettlebells</li> </ul>
<b>ARACK5EPFI RACK5 Fitness Pack</b>	<b>\$3,280.00</b>
Pack includes:	
<ul style="list-style-type: none"> <li>RACK5 and Mat Attachment</li> <li>3 x Ridge Rollers</li> <li>6 x Core Mats</li> <li>2 x 2lb and 4lb Total Grip Medballs</li> </ul>	<ul style="list-style-type: none"> <li>2 x 4lb, 8.8lb and 13lb GRIPPRs</li> <li>11lb and 22lb Corebags</li> <li>2 x 16lb, 24lb and 32lb Studio Kettlebells</li> </ul>



FUNCTIONAL.

# BOXING.

Punch, spar and jab towards a fighting-fit body. The popularity of combat and boxing training is at an all-time high. We have continued to innovate engaging training spaces and long-lasting, durable equipment to ensure that our boxing range stands up to the wear and tear of the toughest workouts.

Boxing lends itself perfectly to group training, and can attract more interest than standard cardio and HIIT workouts. So, whether members are looking to increase their confidence or release their inner fighter, our range provides a knockout performance every time.



**BOX!**  
escape



TRAINING GLOVES	136
BOA MITTS	138
HOOK AND JAB PADS	139
THAI BAG	141
PUNCHBAGS	142

**DEVELOPED  
FOR COMFORT,  
HYGIENE AND  
PERFORMANCE.**



## TRAINING GLOVES.

Gloves for pad or bag work need to be specifically designed for the training environment, not the ring. That's why we created our range of combat staples. These gloves blend durability and usability; lightweight but strong, firm on the strike zone yet cushioned on the palm and fitting is quick due to Velcro wristbands.



BOXING.

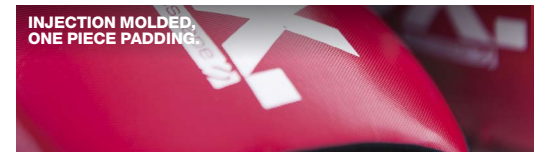

INJECTION MOLDED, ONE PIECE PADDING.

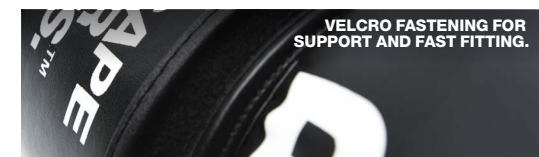

VELCRO FASTENING FOR SUPPORT AND FAST FITTING.



EASY CLEAN, HYGIENIC TECHNOLOGY.

<b>EBOX-TG10R</b>	10oz Training Gloves – Red	<b>\$59.00</b>
<b>EBOX-TG12B</b>	12oz Training Gloves – Black	<b>\$59.00</b>



## BOA MITTS.

Pack a punch, seamlessly from start to finish, as thanks to their open-palm design, there's no need to remove these mitts when switching between bag work and handling functional training tools. They bring an authentic feel to any combat training session, but really come alive when used in a fusion of combat and functional training.



<b>MITT001</b>	BOA Mitt - Medium	<b>\$40.00</b>
<b>MITT002</b>	BOA Mitt - Large	<b>\$40.00</b>



BOXING.

## CURVED HOOK AND JAB PADS.

Designed to test your strike accuracy, these pads provide a target to hit and fine-tune your combinations. The dual-density palm pads, and ability to spread your hand wide to absorb punches via the individual finger placements, ensure that it's the pads that take the beating, not your hands.



**EBOX-CHJP** Curved Hook and Jab Pads – Pair **\$52.50**

**SPECIFICATION.**

Size: 3" x 8".

**PERFORMANCE  
EVEN FOR  
THE MOST  
AGGRESSIVE.**



## THAI BAG.

A great fit for any functional or combat-focused space, this full-length Thai bag is ideal for Muay Thai and MMA style workouts incorporating punches, kicks, elbows and knees. The stronger, more durable material straps on the Thai Bag make it much quieter than the traditional chain-strapped bags, enabling combat programs to coincide more harmoniously with other gym sessions.

**STRAPS.**  
Durable straps for noise reduction.

**DESIGN.**  
The bag is covered in a non-slip material, reflecting the benefits of making an impactful connection with each hit.

**ANTI SWING.**  
There's also a loop attached to the base, enabling it to be tied securely in place.



BOXING.

**ATHAI01** Thai Bag **\$665.00**

**SPECIFICATION.**  
Size: 65" x 14". Weight 99lb.





## FREESTANDING PUNCHBAG.

This entry-level freestanding bag will challenge users of every ability without the need for permanent fixtures and fittings.



**TARGETS.**  
Durable PVC coated polyester with two-level target zones.

**DESIGN.**  
Monochrome design to fit into any style of fitness space.

**BASE.**  
Moveable base for easy storage when not in use.

**AFSPB01** Freestanding Punchbag **\$820.00**

**SPECIFICATION.**  
Size: 46" x 15". Weight 16.5lb empty, 275lb full.



## HEAVY PRO PUNCHBAG.

Let your members put in the work with this premium heavy boxing bag, designed to withstand maximum punishment without the same resulting noise of other bags.



**DESIGN.**  
Made from PVC-coated polyester with polyester lace stitching.

**STRAPS.**  
Durable straps for noise reduction.

**AHVPB01** Heavy Pro Punchbag **\$595.00**

**SPECIFICATION.**  
Size: 50" x 16.5". Weight 100lb.

## TRAINING BAG.

This punchbag is filled in the traditional way with recycled rags and fabric to create a bag that provides a total body workout. It may be a more affordable bag, but pound for pound it still delivers a knockout performance.



**EBOX-PB** Training Bag **\$280.00**

**SPECIFICATIONS.**

Size: 30.5" x 14". Weight 59.5lb

**WHILST STOCKS LAST.**



BOXING.

## AQUA PUNCHBAG.

Ideal for a variety of striking exercises for boxing, MMA or general fitness, this heavy duty bag offers increased safety and a much more responsive feel than many traditional bags.

**DESIGN.**

The unique teardrop shape makes the Aqua Bag ideal for training any style of striking.

**MATERIALS.**

Water filled vinyl container for realistic punch feedback.

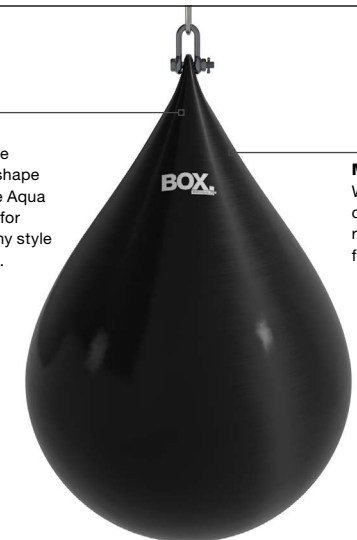

**WHILST STOCKS LAST.**

**AQUAB55** Aqua Punchbag **\$235.00**

Aqua punchbag includes:

- D-bolt with lag screw
- Nozzle
- Rope

**SPECIFICATIONS.**

Size: 30" x 13". Weight 187lb

TURN TO PAGE 187 FOR WARRANTIES

# FLEXIBILITY.

To boost your all-round performance, it's important to focus first on your foundations. Work on flexibility, mobility and posture alongside every training session and your overall fitness and health will reap the benefits. Refresh tired muscles, revive key joints and condition the core with our bright, engaging range of mobility equipment, designed to help everyone get the most from every workout.



FLEXIBILITY.

MATS	148
YOGA BLOCK AND STRAP	150
ROLLERS	155
GYM BALLS	156
POWER AND RESISTANCE TUBES	159

# MATS.

Our range of mats has been expertly designed and constructed, offering the greatest possible experience to a user – seasoned pro or absolute beginner alike. They are versatile, hard-wearing and hygienic.



## COMPARISON CHART.

FEATURES.	YOGA MAT.	CORE MAT.	FLEX MAT.	MULTI MAT.
USE	Yoga	General use, crunches, stretches	Stretching, Pilates	Stretching, balance, massage, floor exercises
MATERIAL	PVC	PVC with foam inner	Memory foam	PVC with compound foam and polyurethane granule inner
AREA	Yoga studios	PT spaces, stretch areas	Pilates, mind & body studios	PT spaces, stretch areas
SIZE	72" x 24" x ¼"	40" x 20" x ¾"	72½" x 24" x ¾"	79" x 39" x 1"
FEATURE	Central alignment markings, sticky feel	Easy clean and wipe down, cushioning	Non-marking base, high grip	Durable but cushioned, anti-slip surface
EYELETS	Yes	Yes	Yes	No
WARRANTY	1 year	1 year	1 year	2 years

# HOW TO CHOOSE.

## YOGA MAT.

This mat features a centered dotted line for guidance, which makes it the ideal mat for beginners.

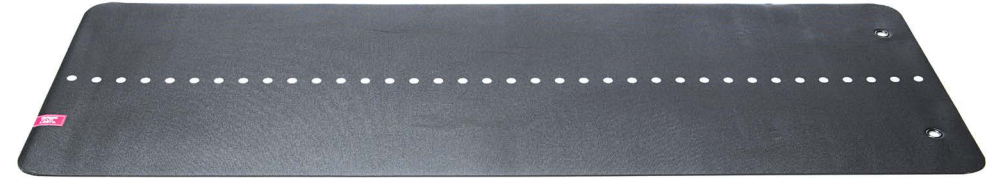

## CORE MAT.

A hard-wearing, easy-to-clean and hygienic mat that is perfect for core conditioning within studio work.



## FLEX MAT.

A high-grip, textured surface featuring a fast-acting memory foam that returns quickly to its original shape.



## MULTI MAT.

PVC covering and compound foam create an easy-to-clean, versatile and comfortable mat, at home in any studio.



FLEXIBILITY.

## YOGA MAT.

Our Yoga Mat is made from compact foam and has been designed to allow for more grip and comfort when performing yoga moves.

**DESIGN.**  
The mat features a central white positioning guide for hand and feet alignment.



Eyelets for hanging on Escape's mat storage racks.

**COMFORT.**  
The material used for the Yoga Mat is chosen for its excellent grip, comfort and easy-clean properties.

**YMAT01** Yoga Mat – Black **\$34.50**

**SPECIFICATION.**  
Size: 68" x 24" x 0.12".

## YOGA BLOCK AND STRAP.

### YOGA BLOCK.

The Yoga Block is made from high-quality foam and is heavier, stronger and will last longer than most lightweight alternatives.

### YOGA STRAP.

The Yoga Strap allows users to achieve those hard-to-reach yoga positions. It will stay in place thanks to the robust buckle that securely holds the strap at the right length.



**YBLOCK1** Yoga Block – Black **\$17.50**

**EST-YOGS** Yoga Strap **\$5.50**

**SPECIFICATIONS.**  
**YBLOCK1:** Size: 9" x 5.5" x 3".  
**EST-YOGS:** Size: 67.33".

# A YOGA MAT THAT'S READY TO GO, WHATEVER YOUR FLOW.



YOGA MAT.

YOGA BLOCK.

YOGA STRAP.

FLEXIBILITY.

## CORE MAT.

Whatever your exercise needs – stretching, mind, body and balance – this specially formulated non-slip foam mat is perfect.

**MATERIALS.**  
Welded and laminated PVC cover with foam inner.



**DESIGN.**  
The cool anthracite color will provide your studio with a calm and relaxed atmosphere.



Eyelets for hanging on Escape's mat storage racks.

**EST-CMATA** Core Mat – Anthracite

**\$48.50**

**SPECIFICATION.**  
Size: 40" x 20" x 0.37".

## FLEX MAT.

Two-sided, multi-purpose, non-marking base with a high-grip surface that has been designed specifically to provide extra comfort and grip, ideal for Pilates and stretching.

**DESIGN.**  
The Flex Mat is more than three times thicker than a regular yoga mat, with a specially formulated non-slip base.



**DOUBLE-SIDED.**  
The Flex Mat incorporates one black side, and one grey side.

**MATERIALS.**  
Fast-reacting memory foam quickly returns to its original shape so you can work out without stopping to rearrange your mat.



Eyelets for hanging on Escape's mat storage racks.

**EST-FMGRY** Flex Mat – Anthracite

**\$64.00**

**SPECIFICATION.**  
Size: 72½" x 24" x 0.37".

# DON'T SACRIFICE ON SUBSTANCE OR STYLE. HAVE BOTH.



FLEXIBILITY.



## MULTI MAT.

A large, hard-wearing stretch mat that covers the full body length. Available in two colors, versatile to suit most applications and durable enough to withstand daily usage.

**DESIGN.**  
These multi-purpose mats are designed for stretching, balance, massage and light floor exercises.

**MATERIALS.**  
The PVC covering with compound foam and polyurethane granules provides extra durability and comfort for the user.



<b>MULTI MAT LARGE.</b>		
<b>M0022B</b>	Multi Mat – Black	<b>\$255.00</b>
<b>M0022</b>	Multi Mat – Gray	<b>\$255.00</b>
<b>SPECIFICATIONS.</b>		
<b>M0022:</b> Size: 79" x 39" x 1" ±10%.		

## ULTRAFLEX ROLLER.

The Ultraflex Roller delivers the ultimate treatment for reviving tired muscles. With a tough, non-porous material that's easy to wipe down.



<b>EST-HFR</b>	Ultraflex Roller – Green	<b>\$66.50</b>
<b>EST-SFR</b>	Ultraflex Soft Roller – Purple	<b>\$48.00</b>
<b>SPECIFICATION.</b>		
Size: 18" x 5.5".		

## UBERSOFT ROLLER.

This large roller is full body length, and eases muscle tension with light massage that helps beginners to achieve greater flexibility and can be used to improve balance.



<b>USR001</b>	Ubersoft Roller – Gray	<b>\$69.50</b>
<b>SPECIFICATION.</b>		
Size: 35.5" x 6".		

## RIDGE ROLLER.

Cool looking yet brilliantly effective, the textured Ridge Roller mimics the pressure applied by a sports massage therapist's hands.



<b>EST-RRC</b>	Ridge Roller	<b>\$60.00</b>
<b>SPECIFICATION.</b>		
Size: 15" x 5.5".		

FLEXIBILITY.

# STEADYBALL PRO.™

A studio essential for balance, flexibility and strength, the Steadyball Pro is the best on the market with an unstable surface, but no sagging. Trusted to keep its rigidity, not squash and hold its shape, no matter the exercise.

**BURST RESISTANT.**  
Burst resistant tested (brt) (770lbs).

**MATERIALS.**  
Made from PVC material and textured to provide grip from any direction.

**STORAGE.**

Arranged by size, keep Steadyballs tidy with a choice of three up to 12 ball shelving options



<b>SBP55</b>	21.5"	Steadyball Pro - Light Gray	<b>\$48.00</b>
<b>SBP65</b>	25"	Steadyball Pro - Dark Gray	<b>\$59.50</b>
<b>SBP75</b>	28.5"	Steadyball Pro - Black	<b>\$72.00</b>
<b>MG-33</b>		Dual Action Pump	<b>\$36.50</b>
<b>RACK SPECIFICATIONS:</b>			
<b>RACKGB3</b>	3 Gym Ball Rack	Size: 36.5" x 27.5" x 82". Weight 55lb.	<b>\$470.00</b>
<b>RACKGB6</b>	6 Gym Ball Rack	Size: 27.5" x 60" x 82". Weight 64lb.	<b>\$600.00</b>
<b>RACKGB9</b>	9 Gym Ball Rack	Size: 44.5" x 60" x 82". Weight 75lb.	<b>\$725.00</b>
<b>RACKGB12</b>	12 Gym Ball Rack	Size: 60" x 60" x 82". Weight 81.5lb.	<b>\$855.00</b>
<b>EST-GBSR</b>	STAKRS Rings		<b>\$14.50</b>

**Steadyball Pro sold separately.**



FLEXIBILITY.





## STEADYBALL™

Designed specifically for core stability and balance work. The unique, safe and stylish two tone Steadyball has self-leveling technology which means it won't roll away.

<b>EST-GB55</b>	55cm Steadyball – Purple	<b>\$40.00</b>
<b>EST-GB65</b>	65cm Steadyball – Green	<b>\$46.50</b>
<b>EST-GB75</b>	75cm Steadyball – Blue	<b>\$52.00</b>
<b>RACK SPECIFICATIONS:</b>		
<b>RACKGB3</b>	3 Gym Ball Rack Size: 36.5" x 27.5" x 82". Weight 55lb.	<b>\$470.00</b>
<b>RACKGB6</b>	6 Gym Ball Rack Size: 27.5" x 60" x 82". Weight 64lb.	<b>\$600.00</b>
<b>RACKGB9</b>	9 Gym Ball Rack Size: 44.5" x 60" x 82". Weight 75lb.	<b>\$725.00</b>
<b>RACKGB12</b>	12 Gym Ball Rack Size: 60" x 60" x 82". Weight 81.5lb.	<b>\$855.00</b>
<b>EST-GBSR</b>	STAKRS Rings (as shown)	<b>\$14.50</b>

Steadyball sold separately.



## POWER TUBES.

**COLOR CODED.**  
Brightly color-coded for easy level recognition.

**TUBES.**  
The elasticised tube is encased in a protective outer covering for added safety.



WHILST STOCKS LAST.

<b>EST-PT1</b>	Power Tube Level 01 – Pink	<b>\$29.50</b>
<b>EST-PT2</b>	Power Tube Level 02 – Green	<b>\$32.00</b>
<b>EST-PT3</b>	Power Tube Level 03 – Blue	<b>\$34.50</b>

## RESISTANCE TUBES.

**HANDLES.**  
Sure-grip handles will not get slippery during tough workouts.

**COLOR CODED.**  
Brightly color-coded for easy level recognition.



<b>EST-RTL1</b>	Resistance Tube Level 01 – Pink	<b>\$21.50</b>
<b>EST-RTL2</b>	Resistance Tube Level 02 – Green	<b>\$22.50</b>
<b>EST-RTL3</b>	Resistance Tube Level 03 – Blue	<b>\$23.50</b>

# FLOORING.

Fitness flooring can support the successful running of a club in several ways, from separating floor space into different zones to protecting members and equipment during workouts. Specialist options like line markings, speed tracks and free weight flooring make a big contribution to the ability of everyone in the gym to perform at their best. Escape uses years of gym experience and technical knowledge to provide the right specialist flooring for clubs that demand the best performance from their investment.

SHOCKTURF	164
SPEED TRACKS	165
FLEXI-TUF	166
FLEXI-SOFT	167
FLEXI-HARD	168
EVERFLEX	169

# FEATURE FLOORING.

The gym floor is unlike any piece of equipment, because it's put through its paces all day, every day. That's why it's just as important as a club's training tools. Clubs are increasingly looking for flooring that adds some style, color and vibrancy to the ambience of the facility. And of course, it should also be carefully chosen to support and protect the club's members, and reduce the stress placed on equipment. We've taken all of these factors into consideration to perfect a quality range of flooring options.

## COMPARISON CHART.

FEATURES.	SHOCKTURF.	PORTABLE SPEED TRACK.	FLEXI-TUF.	FLEXI-SOFT.	FLEXI-HARD.
<b>USE</b>	Functional areas, SAQ, Group X, performance zones, sleds/TIYRs and indoor/outdoor	SAQ areas, TIYRs, sled work, sprint tracks	Free weight areas, some functional areas	Warm-up and stretch areas, yoga and Pilates	Studio areas, light functional training areas
<b>THICKNESS</b>	1" including shock pad	0.5"	0.5"	0.8"	0.8"
<b>PRODUCT SIZE</b>	Rolls from 40' x 6'	6' x 33' or 6' x 39' roll	20" x 20" tile	39" x 39" tile	39" x 39" tile
<b>MATERIALS</b>	Polyethylene and nylon	Polypropylene	Recycled rubber and SBR rubber	EVA tiles	EVA base with a rubber top layer
<b>COLORS</b>	6 base colors with white lines	Green or Black	Black	Available in a range of 4 colors	Available in a range of 4 colors
<b>RECOMMENDED INSTALLATION</b>	DIY or professional install	DIY or professional install	DIY or professional install	DIY or professional install	DIY or professional install

### GIVE MEMBERS INDUSTRY-LEADING TECHNOLOGY.

Across the Escape range, there is flooring that will keep pace with users engaged in a variety of training styles, no matter what is thrown at it. High quality materials make it a durable, long-lasting and effective investment. Our flooring systems offer athletic benefits to end users, protecting their ankles, knees and hips in areas that may involve high impact, plyometric or aerobic training. The materials used include elastomers that adapt to the foot, reducing the risk of injury to members and instructors.

### CREATE SUPERB TRAINING ENVIRONMENTS.

We have dedicated, specialist flooring for every facility's needs – from functional training, free weight areas, sprint tracks and stretching spaces. Let's not forget also that the right flooring can add a huge 'WOW' factor to clubs, transforming workout areas from uninspiring places to breathtaking spaces.

### LET US SUPPORT YOUR PERFECT FLOORING INSTALLATION.

With several flooring options from which to choose, making the right decision isn't always straightforward. That's why our team are here to help you choose products and colors that reflect your unique needs, in terms of performance and aesthetics. The team will work closely with you to assess and choose the flooring that meets your facility's needs, making sure you stand out from the competition.



## SHOCKTURF.

This new-generation synthetic turf flooring has been specifically developed for functional training environments, both indoors and outdoors. It's a true heavy duty product that has consistently performed brilliantly in wear and resistance tests.

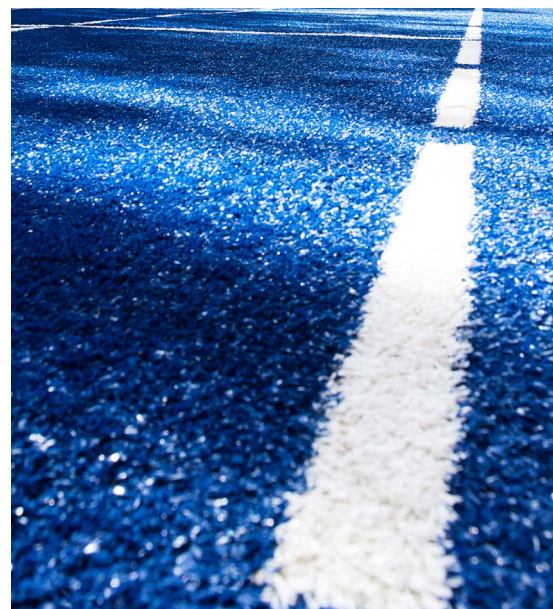

- STURFB** Shockturf - Black
- STURFG** Shockturf - Green
- STURFO** Shockturf - Orange
- STURFR** Shockturf - Red
- STURFS** Shockturf - Slate
- STURFT** Shockturf - Tan

**SPECIFICATION.**  
Roll Size 40ft x 6ft.

**Please contact your sales representative for a quote.**  
Line markings and logos are available – please call for details.

## PORTABLE SPEED TRACK.

The Portable Speed Track provides the perfect basis for agility and explosive power training. Members and their trainers can reap the benefits of a speed track without a permanent installation.

AVAILABLE IN TWO COLORS.



Green Black

<b>APORTST33BLACK</b>	33ft Portable Speed Track	<b>\$8,850.00</b>
<b>APORTST33GREEN</b>	33ft Portable Speed Track	<b>\$8,850.00</b>
<b>APORTST39BLACK</b>	39ft Portable Speed Track	<b>\$9,630.00</b>
<b>APORTST39GREEN</b>	39ft Portable Speed Track	<b>\$9,630.00</b>

Please call for color options and installation details.

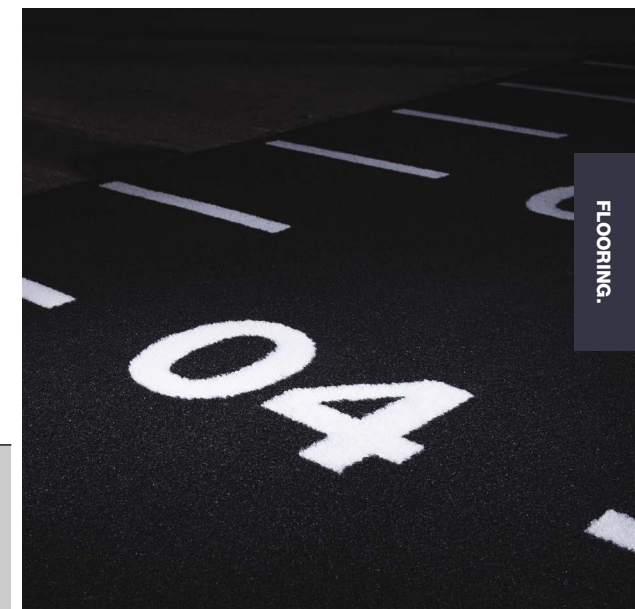

FLOORING.



## FLEXI-TUF.

Flexi-Tuf is a heavy-duty and flexible floor covering that will ensure your free weights and floor are protected from damage and marking.

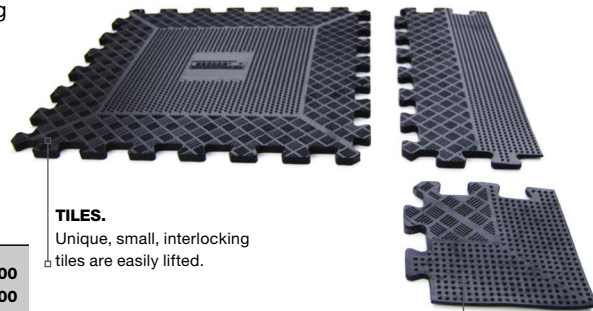

**TILES.**  
Unique, small, interlocking tiles are easily lifted.

**GRIP.**  
Textured surface provides sure footing for maximum confidence during workouts.

<b>MATFT12</b>	Flexi-Tuf Floor Tile	<b>\$50.00</b>
<b>MATES12</b>	Flexi-Tuf Edge Strip	<b>\$18.00</b>
<b>MATCB12</b>	Flexi-Tuf Corner Piece	<b>\$8.50</b>

**SPECIFICATION.**

- MATFT12:** Size: 20" x 20" x 1/2".
- MATES12:** Size: 20" x 7 1/2" x 1/2".
- MATCB12:** Size: 7 1/2" x 7 1/2" x 1/2".

Price is per tile and does not include fitting.



## FLEXI-SOFT.

Soft and slip-resistant modular flooring system for stretching, gym balls and foam rolling. Ideal for yoga studios.

**AVAILABLE IN FOUR COLORS.**



<b>MAT510S</b>	Flexi-Soft Foam Colored Tile	<b>\$145.00</b>
<b>MAT511S</b>	Flexi-Soft Foam Colored Edge Strip	<b>\$47.00</b>
<b>MAT512S</b>	Flexi-Soft Foam Colored Corner	<b>\$10.50</b>

**SPECIFICATION.**

- MAT510S:** Size: 39" x 39" x 3/4".
- MAT511S:** Size: 39" x 7 1/4" x 3/4".
- MAT512S:** Size: 7 1/4" x 7 1/4" x 3/4".

Price is per tile and does not include fitting.

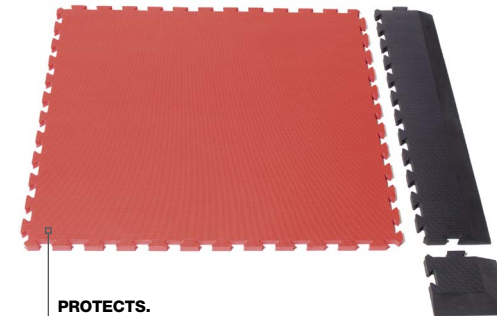

**PROTECTS.**  
Absorbs impact while being comfortable for stretching exercises thanks to the dense foam composition.

FLOORING.



## FLEXI-HARD.

Durable, cushioned flooring for balance exercises, light dumbbell workouts and strength training.

### AVAILABLE IN FOUR COLORS.



<b>MAT510</b>	Flexi-Hard Foam Colored Tile	<b>\$170.00</b>
<b>MAT511</b>	Flexi-Hard Foam Colored Edge Strip	<b>\$50.00</b>
<b>MAT512</b>	Flexi-Hard Foam Colored Corner	<b>\$13.00</b>

### SPECIFICATION.

- MAT510:** Size: 39" x 39" x ¾".
- MAT511:** Size: 39" x 7¼" x ¾".
- MAT512:** Size: 7¼" x 7¼" x ¾".

Price is per tile and does not include fitting.

### USAGE.

Ideal for balance and light-weight exercises with free weights up to a maximum of 44lb.

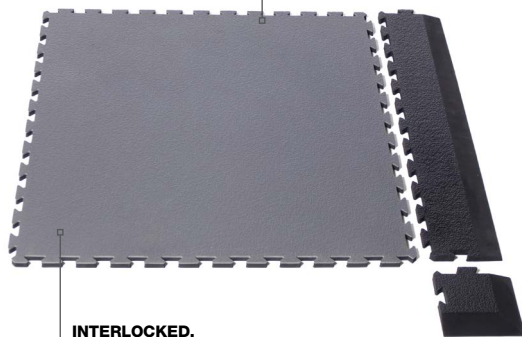

### INTERLOCKED.

The tiles can be interlocked in minutes and don't need to be fixed to the floor.



## EVERFLEX RUBBER FLOORING ROLL.

Floors are the building block of every facility. When envisioning the layout and flooring of a facility, the purpose, function, traffic, and visual impact are all vital considerations. There are so many benefits of Everflex Recycled Rubber Flooring. It's eco-friendly, hard wearing, rugged and durable, easy to clean, and adds aesthetic appeal to training areas.

### SPECIFICATION.

Flooring comes in 4' wide rolls and in three thicknesses of either 1/2", 3/8" or 5/16".

Please call for prices, color options and installation details.

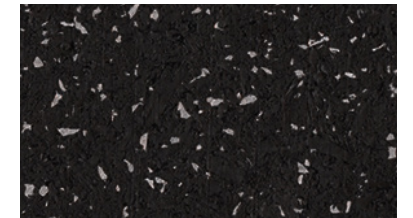

Iron.

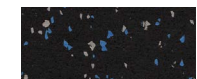

Smoke.



Sand.

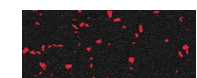

Volcano.

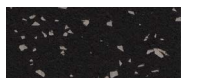

Grey.

FLOORING.

# TRAINING.

The key to achieving motivated members is having coaches and trainers who are knowledgeable and passionate about training tools and techniques. That's what Escape Training is here to help you achieve.



WHY ESCAPE TRAINING	172
IN CLUB GROUP PROGRAMMING	174
ONLINE TRAINING WORKSHOPS	178

TRAINING.

# MEET THE TEAM OF MASTER TRAINERS.

Experience is everything, and Escape understands that we all work better together, sharing insight that we can pass on to our clients, customers, members and gym-goers. That's why we have an extensive range of training experiences, both in digital and face-to-face formats. Each one imparts knowledge about all things fitness, starting at the programming and delivering group training experience, to gamification and much more.



## WHY TRAIN WITH ESCAPE.

The journey to increased revenue and retention can be so much more than just a numbers game. Escape provides an exhaustive experience in every respect, drawing on decades of knowledge for exciting workouts that bring big benefits to business and bodies alike.

Our team of Master Trainers experience this first-hand and discover ways in which they can innovate on what they learn in order to keep clients coming back for more. Join us in person or online for motivation, inspiration and perspiration through a movement revolution that we can lead together.



## BUSINESS IN A BOX.

The rise of the niche-interest experiences proves that people's taste for fitness has changed. There's a growing demand for fun, fast group training, usually in a HIIT style. It's why small studios are doing so well and why established clubs often need to revisit their offering in order to compete – it's survival of the fittest.

Now any club can bring fantastic group training experiences to their members. Escape offers you a suite of programs with everything you need to get going straight out of the box, from small group training to creating a club within a club solution.

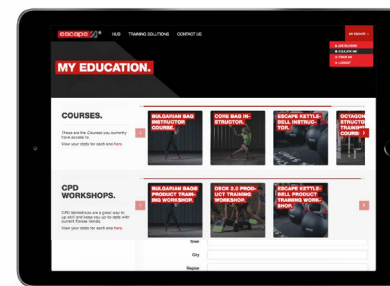

## ONLINE TRAINING COURSES.

With our varied industry and evolving exercise trends, it's more important than ever to ensure your clients/members get the most engaging training experience and the very best results. Education is essential – upskill with Escape.

This system of training supports PTs within gyms, running their own facilities, or taking on the world outside a traditional gym in spaces such as boot camps. The tools provided can be successfully used to stay ahead in business and in fitness.



## INSTRUCTOR TRAINING.

Becoming certified is essential for companies and trainers aiming for the highest level of member experience. Our certification courses are designed to give you the how and why behind training methods, so that trainers gain the confidence to work with any member.

The importance of in-depth research, practical knowledge and real experience are paramount to the way we create our courses. This is why we create the very best course content and support that allows you to deliver the best training to members.





**MOVE IT.**

# MOVE IT.<sup>®</sup> GROUP TRAINING PROGRAM.

**MOVE IT** is designed to achieve the maximal post exercise benefits of HIIT training, developing rest aerobic and anaerobic capacity to new levels. Participants move through a series of workout zones, with intervals, equipment and exercises carefully chosen to challenge energy systems while developing total body, functional strength and endurance.

### WHAT DO MEMBERS GET FROM MOVE IT?

MOVE IT provides a fun, challenging, self-paced workout for members of most fitness levels. It has been designed from the ground up in a way that lets people of different capabilities work out together. The typical MOVE IT participant will be looking for more variety and fun – and better results – than they can get from other workouts. It's the combination of the HIIT approach and the group format that packs such a punch. This leads on to much greater engagement with the club or trainer and a long-term commitment to their fitness journey.

### WHAT TYPE OF CLUB IS IT FOR?

Developed to have mass-appeal, this program is a brilliant way for larger clubs to engage more members than ever in functional training. It turns part of the gym floor into a dynamic, exciting group training space. Smaller group training studios can also achieve results with MOVE IT by integrating it as a key area of programming.

### THE PACKAGE.

Here's what you get in your MOVE IT package:

- Program Principles Manual (binder and online pdf).
- How-to Guide (binder and online pdf).
- Exercise library per workshop (course videos with coaching notes).
- 24 workouts of 30 minutes (course videos with coaching notes).
- 24 workouts of 45 minutes (course videos with coaching notes).
- Warm-up and cool down exercises (course videos with coaching notes).
- 28 bonus workouts (templates with coaching notes).
- 6 fitness tests (templates with coaching notes).
- 7 product training workshops (online access to workshop material including course videos).
- Marketing material (posters, flyers and social media content for you to use).

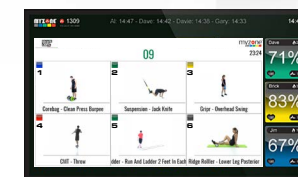

The MOVE IT group training program seamlessly integrates with Myzone, offering further instruction, fitness tracking and gamification to any workout. See **page 223** for more details.

### MOVE IT EQUIPMENT PACKS.

**AMIBEP12** Up to 12 users – MOVE IT Equipment Pack **\$10,050.00**

- x10 Adjustable Hurdles
- x6 CMTs
- x6 GRIPRs
- x2 Ridge Rollers
- x6 Slamball SBX
- x2 Speed Ladders
- x2 Suspension trainer **(ordered separately)**
- x14 Corebags
- x8 Fitness Bulgarian Bags
- x6 Multi-Grip Medballs
- x10 SBX Kettlebells
- x1 Ammo Box

**AMIBEP18** 13-18 users – MOVE IT Equipment Pack **\$13,950.00**

- x10 Adjustable Hurdles
- x9 CMTs
- x9 GRIPRs
- x2 Ridge Rollers
- x8 Slamball SBX
- x2 Speed Ladders
- x3 Suspension trainer **(ordered separately)**
- x20 Corebags
- x12 Fitness Bulgarian Bags
- x8 Multi-Grip Medballs
- x15 SBX Kettlebells
- x1 Ammo Box

**AMIBEP30** 19-30 users – MOVE IT Equipment Pack **\$17,750.00**

- x10 Adjustable Hurdles
- x12 CMTs
- x12 GRIPRs
- x2 Ridge Rollers
- x12 Slamball SBX
- x4 Speed Ladders
- x4 Suspension trainer **(ordered separately)**
- x28 Corebags
- x12 Fitness Bulgarian Bags
- x12 Multi-Grip Medballs
- x20 SBX Kettlebells
- x1 Ammo Box

**PLEASE NOTE:** A Suspension trainer is essential for MOVE IT. Suspension trainers must be ordered separately.

**MIB001** MOVE IT Training Program **\$2,800.00**

**MIB100** Additional face to face training - two day course (can only be purchased with MIB001)

Additional face-to-face product training workshops:

- Kettlebell
- Corebag
- Bulgarian Bag
- GRIPR
- CMT
- SMR with Foam Rollers

**Face-to-Face Product Training Workshops - please contact your sales representative for a quote.**

# READY TO HIIT YOUR WHOLE BODY?



## HIIT THE DECK. GROUP TRAINING PROGRAM.

Imagine a large group or a compact boutique studio space, full of people moving quickly between step routines, plyometric jumps, resistance band work and bench presses. Using just the Escape Deck 2.0 and a handful of other carefully-chosen tools, we've created a program package that makes it possible.

### WHAT DO MEMBERS GET FROM HIIT THE DECK?

HIIT THE DECK works superbly as an introduction to functional training for members who have had limited exposure to it so far. It includes exercises and workouts embracing cardio, strength and plyometrics, giving people a fantastic whole body experience. Instructors can also ramp up the intensity for more advanced members. The pace and resistance levels can be increased according to participant fitness levels: there is no limit on the amount of challenge that can be achieved with HIIT THE DECK.

### WHAT TYPE OF CLUB IS IT FOR?

Thanks to its suitability for members of almost all abilities, this is an incredibly flexible solution that includes programming for PTs, standalone small group studios and boutiques, and large group studio spaces. It can be run as one of several programs in a club, but the sheer scale and variety of workouts means it also has the potential to be used as the basis for a club's entire programming.

### WHAT'S INCLUDED?

There are instruction manuals for trainers, 45-minute large group workouts (and the music to go with them), 20-minute small group workouts, one-to-one PT workouts, specialist boutique workouts and an exercise library covering all of the workout components.

### THE PACKAGE.

Here's what you get in your HIIT THE DECK package:

- Training and operations manual (binder and online pdf).
- Exercise library per workshop (course videos with coaching notes).
- 6 exercise-to-music workouts of 45 minutes for large group programming (course videos, coaching notes and ready-to-download music).
- 10 workouts of 20 minutes for small group programming (course videos with coaching notes).
- 6 workouts for personal training (course videos with coaching notes).
- 128 specialist boutique studio workout interval protocols covering lower, upper, core and total body (course videos with coaching notes).
- The Deck Time Trial (video and template document).
- Marketing material (posters, flyers and social media content for you to use).



<b>HTD001</b>	HIIT THE DECK Training Program	<b>\$2,800.00</b>
<b>HTD100</b>	HIIT THE DECK face to face training - one day course (can only be purchased with HTD001)	
Additional face-to-face product training workshops:		
▪ Bulgarian Bag	▪ DECK 2.0	
▪ GRIPR		

**Face-to-Face Product Training Workshops - please contact your sales representative for a quote.**

HIIT THE DECK CLUB EQUIPMENT PACKS - PER PERSON	
<b>AHTDBEB1</b> Beginner Pack	<b>\$850.00</b>
▪ x1 DECK	▪ x2 5lb Urethane Dumbbells
▪ x1 Resistance Tube Level 2	▪ x2 15lb Urethane Dumbbells
▪ x2 8.8lb GRIPR	▪ x1 12lb Bulgarian Bag
<b>AHTDBEA1</b> Advanced Pack	<b>\$1,155.00</b>
▪ x1 DECK	▪ x2 25lb Urethane Dumbbells
▪ x1 Resistance Tube Level 3	▪ x2 35lb Urethane Dumbbells
▪ x2 13.2lb GRIPR	▪ x1 17lb Bulgarian Bag

**PLEASE NOTE:** One pack is required per participant in a class.

# PRODUCT TRAINING WORKSHOPS.

Trainers and coaches can develop comprehensive skills and knowledge with our product training workshops. Each workshop includes video demonstrations of multiple exercises, created by Escape's Master Trainers. It's like having product experts deliver one-to-one instruction, but with the convenience of online delivery.

In addition to the online delivery format, we also run two-hour product training workshops in clubs for groups of trainers. Clubs typically purchase three or four workshops (covering different products) to run on the same day. Participants in the in-club workshops also enjoy full access to the online support materials.

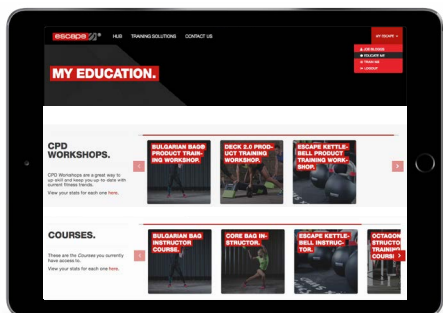

<b>TRAIN01</b>	Battle Rope - product training workshop	<b>\$79.00</b>
<b>TRAIN02</b>	Bulgarian Bag - product training workshop	<b>\$79.00</b>
<b>TRAIN03</b>	Kettlebell - product training workshop	<b>\$79.00</b>
<b>TRAIN04</b>	Medicine Balls - product training workshop	<b>\$79.00</b>
<b>TRAIN05</b>	TIYR - product training workshop	<b>\$79.00</b>
<b>TRAIN06</b>	GRIPR - product training workshop	<b>\$79.00</b>
<b>TRAIN07</b>	Plyometrics - product training workshop	<b>\$79.00</b>
<b>TRAIN08</b>	Corebag - product training workshop	<b>\$79.00</b>
<b>TRAIN09</b>	SMR Rollers - product training workshop	<b>\$79.00</b>
<b>TRAIN10</b>	Sandbag - product training workshop	<b>\$79.00</b>
<b>TRAIN11</b>	CMT - product training workshop	<b>\$79.00</b>
<b>TRAIN12</b>	DECK 2.0 - product training workshop	<b>\$79.00</b>
<b>TRAIN13</b>	TIYR Sport - product training workshop	<b>\$79.00</b>

**Face-to-face product training workshops - only available in packs:**

**PTB3PACK** Product training workshop - 3 pack

**PTB4PACK** Product training workshop - 4 pack

**Face-to-Face Product Training Workshops - please contact your sales representative for a quote.**

# MASTER ANY MOVEMENT.

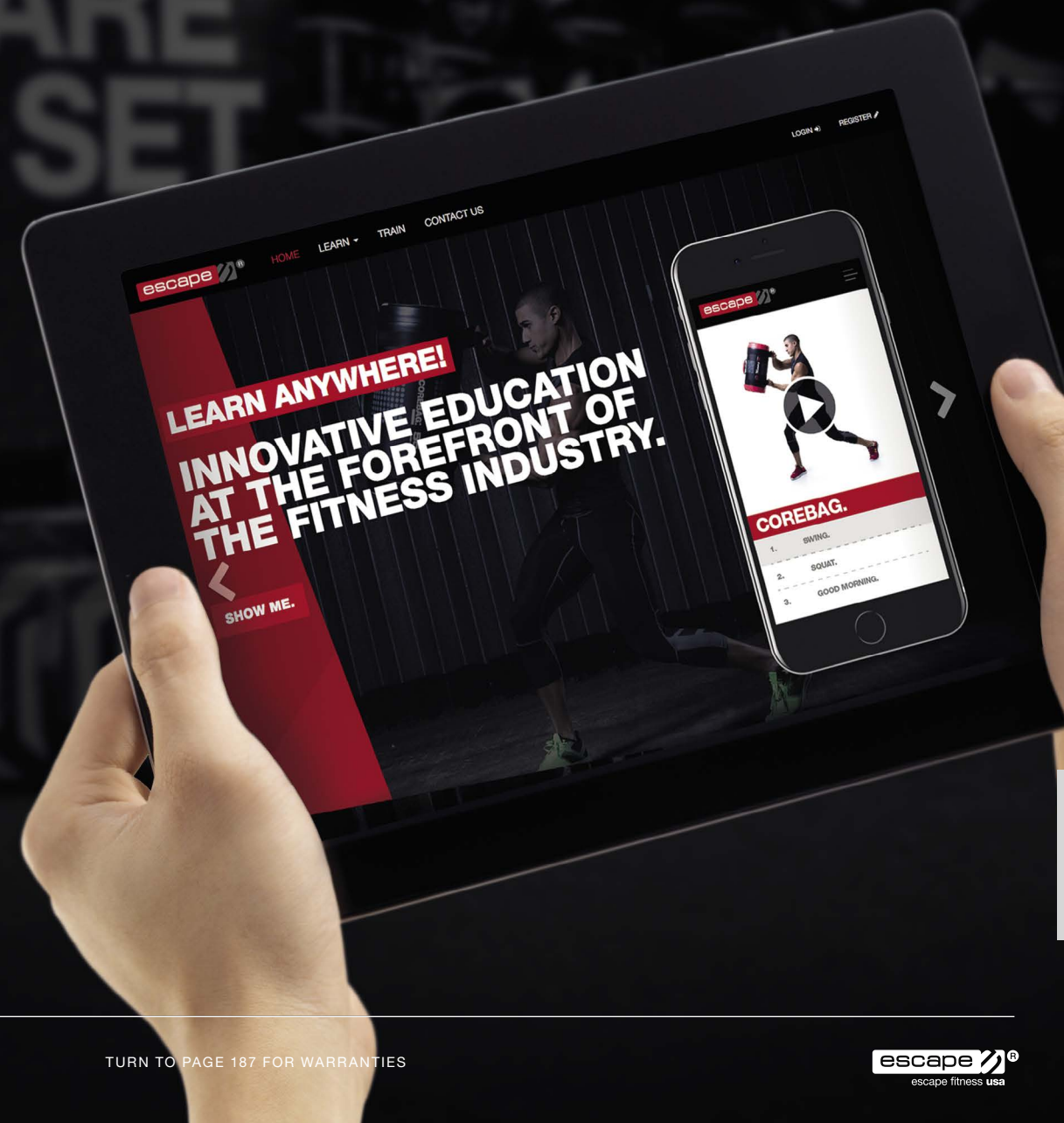

### FIND YOUR NICHE.

More and more fitness spaces are finding a niche and servicing specific interests of clients; the same goes for entrepreneurial personal trainers, too. With Escape product training, you can pick exactly what you want to master, and become a pro with any performance tool.

### ACCESS ANYWHERE.

Escape Training leads the way in functional training methods and provides you with real world, practical tools to use instantly. Through Escape training, you can also access our PT Live seminars, where you can learn from industry leaders wherever you are.

### FOR GYM OWNERS OR GO-IT-ALONERS.

These are the perfect workshops to empower a PT to deliver exciting training sessions to their clients. These workshops also ensure that club owners purchasing the equipment can enable their trainers to teach safe use of it and maintain it correctly.

# INDEX.

## A

Adjustable Bench .....48  
Adjustable Hurdle .....107  
Agility Grid System .....107  
Ammo Box .....126, 130  
App, Escape.....09  
Aqua Punchbag .....145  
Attachments, Octagon .....86-91

## B

Bags  
Boxing .....142-145  
Bulgarian Bags, Fitness .....113  
Corebags .....114  
Storage Rack .....115, 125  
Thai .....141

## Balls

ENDURA .....119  
Gym .....156-158  
Multi Grip .....122  
Slamball SBX .....124  
Storage Racks .....119-124, 125  
Total Grip .....122  
VERTBALL .....120  
VERTMINI .....121

Barbells .....26  
Curl, Urethane .....26  
Fixed, Urethane .....26  
Storage and Sets .....27

Bands, Power .....130  
Bar Holder, Olympic .....44  
Barrow .....103

## Bars

Curl .....43  
Power .....43  
Storage .....44  
WOD .....43

BASE BENCH .....91  
Battle Ropes .....127  
Before You Order .....182  
Bench, Adjustable .....48  
BOA Mitts .....137  
BOA Rail, Octagon .....84

## Boxes

AMMO Box .....126, 130  
Multiplio .....109  
Plyosoft Boxes .....108, 110  
STRONGBOX .....46

Boxing .....84-85, 131, 134-145  
Aqua Punchbag .....145  
BOA Mitts .....137  
BOA Rail, Octagon .....84  
Boxing Frame, Octagon .....85  
Freestanding Punchbag .....142  
Heavy Pro Punchbag .....143  
Pads, Curved Hook and Jab .....139  
Punchbags .....142-145  
Ropes .....131  
Thai Bag .....141  
Training Bag .....144  
Training Gloves .....137  
Boxing Frame, Octagon .....85  
Bumper Plates .....40-41  
Bulgarian Bags, Fitness .....113

## Boxes

AMMO Box .....126, 130  
Multiplio .....109  
Plyosoft Boxes .....108, 110  
STRONGBOX .....46

## C

Clamp Collar, Olympic.....44  
CMT, Core Momentum Trainer .....128  
Collars.....44

Color Options, Octagon .....98-99  
Competition Pro Kettlebells 2.0 .....30  
Core Mat .....152  
Corebags .....114  
Corner Storage, Octagon .....125  
Cross Training Jump Rope .....131  
CRUX Rope Pulley .....87  
Curl Bar .....43  
Curled Barbells .....26  
Curved Hook and Jab Pads .....139  
Customisation, Octagon .....92-99

## D

DECK 2.0 .....49  
Designed to Order, Octagon .....92-99  
Digital .....06-09  
Dual Action Pump .....156  
Dumbbells .....16-25  
Nucleus .....16-17, 22-25  
SBX .....17, 22-25  
STAKRBELL .....19, 49  
Storage Racks and Sets .....16-17, 20-25  
Urethane .....16, 22-25

## E

Education, Escape Training....170-179  
Elite Urethane Bumper Plates .....40  
ENDURA Ball .....119  
Escape Your Limits App.....09  
Escape Your Limits Podcast.....08  
Everflex Flooring .....169

## F

Fitness Bulgarian Bags .....113  
Fitness Jump Rope .....131  
Fitness Pack – RACK5 .....133  
Fixed Barbells .....26  
Flexibility .....146-159  
Flooring .....160-169  
Lift Zone .....45  
Everflex .....169  
Flexi-Hard .....168  
Flexi-Soft .....167  
Flexi-Tuf .....166  
Portable Speed Track .....165  
Shockturf .....164  
Flex Mat .....152  
Flexi-Hard Flooring .....168  
Flexi-Soft Flooring .....167  
Flexi-Tuf Flooring .....166  
Frames .....52-99  
T1 .....56-59  
BOA Rail .....84  
Boxing Frame, Octagon .....85  
Boxing Frame .....85  
Freestanding .....66-67, 71, 78  
Freestanding MONO .....80  
Freestanding Squat Hub .....78  
Half Box .....77  
Half Squad .....80  
HIT Hubs .....60-67  
HTS .....68-71  
HTS 90 .....72-73  
Octagon .....75  
QUAD .....79  
WOD Box .....77  
Freestanding MONO .....80  
Freestanding Punchbag .....142  
Freestanding Squat Hub .....78  
Functional .....100-133

## L

Lift Zone .....45  
Lateral Endurance Hurdle .....107  
Low Level Storage, Octagon .....125

## M

MARS .....06-07  
Mats .....148-154  
Core .....152  
Flex .....152  
Multi .....154  
Yoga .....150  
Medballs .....116-124  
ENDURA Ball .....119  
Multi Grip .....122  
Slamball SBX .....124  
Storage .....119-124  
Total Grip .....122  
VERTBALL .....120  
VERTMINI .....121  
Mitts, BOA .....137  
MONO, Freestanding Octagon .....80  
MOVE IT Group  
Training Program .....175  
Multi Grip Medballs .....122

Functional Pack – RACK5 .....133

## G

Gloves, Training .....137  
Grip Plates, Rubber .....38  
Grip Plates, Urethane .....38  
GRIPR .....126  
Group Training Programs .....174-177  
Gym Balls  
Dual Action Pump .....156  
Holder, RACK5 .....132  
Steadyball .....158  
Steadyball Pro .....156  
Storage .....156-158  
Gym Designs .....188-189

## H

Half Box, Octagon .....77  
Half Squad, Octagon .....80  
Heavy Pro Punchbag .....143  
HIIT THE DECK Group Training Program .....177  
HIT Hub Frames, Octagon .....60-67  
Hook and Jab Pads, Curved .....139  
HTS 90, Octagon .....72-73  
HTS Frames, Octagon .....68-71  
Hurdles  
Adjustable .....107  
Lateral Endurance .....107

## I

Instructor Training.....178

## J

Jump Ropes.....131

## K

Kettlebells .....28-35  
Competition Pro 2.0 .....30  
SBX .....32  
Storage Racks and Sets .....30-35, 125  
Studio .....34

## L

Lift Zone .....45  
Lateral Endurance Hurdle .....107  
Low Level Storage, Octagon .....125

## M

MARS .....06-07  
Mats .....148-154  
Core .....152  
Flex .....152  
Multi .....154  
Yoga .....150  
Medballs .....116-124  
ENDURA Ball .....119  
Multi Grip .....122  
Slamball SBX .....124  
Storage .....119-124  
Total Grip .....122  
VERTBALL .....120  
VERTMINI .....121  
Mitts, BOA .....137  
MONO, Freestanding Octagon .....80  
MOVE IT Group  
Training Program .....175  
Multi Grip Medballs .....122

Multi Mat .....154  
Multi Use Racks,  
Rigid.....114-115, 119-120, 123-124  
Multiplio .....109

## N

Nucleus  
Barbells .....26  
Dumbbells .....16-17, 22-25  
Grip Plates .....38  
Kettlebells .....32

## O

Octagon Frame Range .....52-99  
Attachments .....86-91  
BASE BENCH .....91  
BOA Rail .....84  
Boxing Frame .....85  
Color Options .....98-99  
Corner Storage .....125  
CRUX Rope Pulley .....87  
Designed to Order .....92-99  
Freestanding  
Frames .....66-67, 71, 78, 80  
Freestanding MONO .....80  
Freestanding Squat Hub .....78  
Half Box .....77  
Half Squad .....80  
HIT Hub Frames .....60-67  
HTS 90 .....72-73  
HTS Frames .....68-71  
Octagon .....75  
QUAD .....79  
Storage Racks .....24, 30-35  
T1 .....56-59  
The STACK .....89  
WOD Box .....77  
Olympic Bar Holder .....44  
Olympic Clamp Collar .....44  
Olympic Spring Collar .....44  
Online Product Training  
Workshops .....178

## P

Pads, Curved Hook and Jab .....139  
Plates .....36-41  
Elite Urethane Bumper .....40  
Rubber Bumper .....41  
Rubber Grip .....38  
Storage .....39-41  
Urethane Grip .....38

## Platforms

DECK 2.0 .....49  
Lift Zone .....45  
STEP and RISER .....50-51  
Plyosoft Boxes .....108, 110  
Podcast .....08  
Portable Speed Track .....165  
Power Bar .....43  
Power Bands .....130  
Power Tubes .....159  
PRO BOUNDER .....129  
Product Training Workshops .....178  
Pulley, CRUX .....87  
Punchbags .....142-145

## Q

Quad Sled .....106  
QUAD, Octagon .....79

## R

RACK5 .....113-114, 119-121,  
123-124, 132-133  
Gym Ball Holder .....132  
Mat Attachment .....132  
Product Packs .....133  
Shelving .....133  
Racks and Storage  
Ammo Box .....126, 130  
Barbell .....27  
Bars .....44  
Corner Storage, Octagon .....125  
DECK 2.0 .....49  
Dumbbell .....16-17, 20-25  
Gym Ball .....156-158  
Kettlebells .....30-35  
Multi Use Racks,  
Rigid .....114-115, 119-120, 123-124  
Plates .....39-41  
RACK5 .....113-114, 119-121,  
123-124, 132-133

Toast .....40-41  
Weight Tree .....39  
Resistance Tubes .....159  
Rigid Storage Racks  
Barbell .....27  
Bars .....44  
Dumbbell Racks .....16-17, 25  
Kettlebell .....30-35  
Multi Use .....114-115, 119, 123-124  
Plates .....39  
Vertical Dumbbell Rack .....22  
XRACK 2.0 .....23  
Ridge Roller .....155  
Rings, WOD .....127  
RISER .....50-51  
Rollers  
Ridge Roller .....155  
Ubersoft Roller .....155  
Ultraflex Roller .....155  
Rope Pulley, CRUX .....87  
Ropes .....127, 131  
Rubber Bumper Plates .....41  
Rubber Grip Plates .....38

## S

SBX Dumbbells .....17, 22-25  
SBX Kettlebells .....32  
Shelving, RACK5 .....133  
Shockturf .....164  
Slamball SBX .....124  
Sled, Quad .....106  
Speed Cones .....107  
Speed Ladder .....107  
Speed Track, Portable .....165  
Speed Training .....107  
Adjustable Hurdle .....107  
Agility Grid System .....107  
Lateral Endurance Hurdle .....107  
Speed Cones .....107  
Speed Ladder .....107  
Spring Collar, Olympic .....44  
Squat Hub, Freestanding .....78  
STACK, The .....89  
STAKR Rings .....156-158  
STAKRBELL .....19, 49  
Steadyball .....158  
Steadyball Pro .....156

STEP and RISER.....50-51  
Storage Racks and Sets,  
Dumbbells .....16-17, 20-25  
Storage Racks and Sets,  
Kettlebells .....30-35  
Storage Racks and Sets, Plates 39-41  
Storage Racks, Octagon .....24, 30-35  
Storage Racks,  
Rigid .....22-23, 25, 27, 30-35, 39  
Strength .....10-51  
STRONGBOX .....46  
Studio Kettlebells .....34

## T

T1, Octagon .....56-59  
Terms and Conditions .....184-186  
Thai Bag .....141  
TIYR .....105  
Toast Rack .....40-41  
Total Grip Medball .....122  
Training Bag .....144  
Training Gloves .....137  
Training, Escape Education ...170-179  
Tubes, Power .....159  
Tubes, Resistance .....159

## U

Ubersoft Roller .....155  
Ultraflex Roller .....155  
Ultra Low Level Storage,  
Octagon .....125  
Urethane Barbells .....26-27  
Urethane Dumbbells .....16, 22-25  
Urethane Elite  
Bumper Plates .....40  
Urethane Grip Plates .....38

## V

VERTBALL .....120  
Vertical Dumbbell Rack .....22  
VERTMINI .....121

## W

Warranties .....187  
Weight Tree .....39  
WOD Bar .....43  
WOD Box, Octagon .....77  
WOD Collar .....44  
WOD Rings .....127  
Workout Screen .....06

## X

XRACK 2.0 .....23

## Y

Yoga Block and Strap .....150  
Yoga Mat .....150

# BEFORE YOU ORDER.

As exclusive Business to Business suppliers of Fitness Equipment to the Industry, Escape aims to make the Customer buying experience efficient and informative. Orders placed with Escape are subject to the standard Terms and Conditions of Business ("Conditions") contained in the following pages to the exclusion of any other terms or conditions that the Customer seeks to impose or incorporate or that may be implied by trade custom, practice or course of dealing. In the event that Goods are sold on to a third party, it is the Customer's responsibility to ensure the ultimate purchaser is fully acquainted with, and accepts the Conditions overleaf. No variation of these Conditions shall be effective unless expressly agreed in writing by an Escape authorized signatory.

## US DELIVERY

Most Orders will be delivered as parcels by independent carriers. Where large Orders cannot be delivered as parcels, the Order will be delivered on pallets to the exterior access point of the delivery address (Freight prices available on application.) The Customer must provide adequate manpower to unload the Goods and dispose of all packaging supplied for transit.

## Product assembly and installation

Please note that functional frames and equipment storage racks will require assembly after delivery.

## Customized, bespoke and special order products

Once an Order has been placed and an Order Confirmation issued in respect of Goods that are customized, bespoke or special order, it cannot be amended or cancelled. Goods are customized when an element of the product is changed e.g. the Customer's brand color or logo is added. Bespoke Goods are specifically designed for the Customer and include, but are not limited to, flooring, functional frames and storage solutions. Special order Goods include products that are not normally held in stock or are ordered in a large quantity e.g. MARS or storage racks. Escape do not accept any liability for loss or damage incurred or suffered by the Customer as a result of inaccuracies made by them in the Order process. Accurate measuring is essential.

## MEASURING AND SURVEYS.

When ordering large/heavy equipment or flooring, it is important that accurate measurements of the relevant area are supplied to ensure equipment will fit and can be used safely. Accurately measuring access points, corridors, elevators, stairs, and their height is equally important to ensure smooth delivery and installation. Escape recommends that all Customers arrange a survey which takes account of all these factors as well as the suitability of the product for a particular location.

## DAMAGES AND DELIVERY DISCREPANCIES.

All deliveries must be checked as soon as received and before the delivery note is signed as any discrepancy or damage in the consignment must be notified to Escape immediately, and within 48 hours at the latest. Please note the time of delivery as recorded on the delivery note. If a discrepancy is identified, the Customer should telephone Escape's Customer Services Department with full details of the Goods ordered and the damage or discrepancy identified. At its sole discretion, Escape will either replace or repair the Goods. Reports of damage or discrepancy will not be entertained after the expiration of 48 hours from the time of delivery as recorded on the delivery note or similar device operated by the carrier.

## CANCELLATIONS AND RETURNS (NOT APPLICABLE TO CUSTOMIZED, BESPOKE AND SPECIAL ORDER GOODS).

Once a quotation is accepted by the Customer placing an Order, Escape will issue an order confirmation. The customer may amend or cancel the Order within 14 days of the Order Confirmation and provided the Order has not been dispatched. A fee of 10% of the Order value will be charged to cover administration costs. Escape reserve the right to reduce the above fee, in its sole discretion when the amendment sought by the Customer is "de minimis" or there are other exceptional circumstances justifying the same.

Where Goods have been dispatched, the Customer may return some or all of the Goods for up to 14 days after receipt (as recorded by the carrier) provided that the Goods are returned to the supplier at the Customer's cost and in new and unused condition with all the original labels and packaging intact. A fee of 20% of the Order value will be charged to cover administration and stock handling costs. Goods may not be returned unless a returns reference number has been issued by Escape's Customer Service Department.

## NON-RETURNABLE ITEMS.

Unless Goods are damaged or faulty, any customized, bespoke, or specially ordered equipment or flooring cannot be returned once an Order Confirmation has been issued. Items such as floor mats, gloves, mitts etc cannot be returned once dispatched for hygiene reasons.

## PRODUCT MEASUREMENTS.

All sizes, weights and measurements are approximate.

## ORDERING MADE EASY.

### Four ways to order:

1. **Phone:** 614-706-4462
2. **Website:** [www.escapefitness.com/us](http://www.escapefitness.com/us)
3. **Email:** [salesusa@escapefitness.com](mailto:salesusa@escapefitness.com)
4. **Post:** Escape Fitness USA LLC  
4434 Muhlhauser Road, Suite 300,  
Cincinnati OH 45011.

### When placing an Order by post, the Customer should:

1. Quote the product code, product description, quantity required, price and freight costs.
2. Include their unique purchase Order number (for account Customers this must have been authorized by an appropriate signatory).
3. Print the name, department and position of the person placing the Order.
4. Confirm the method of payment.
5. Provide full postal delivery address.  
NB Customers purchase Orders are only accepted from pre-approved Customers or account holders.

## PRICES

All prices are in USD and exclude freight and tax. Trade accounts and bulk Orders may attract special pricing.

## PAYMENT

Customers may use the credit/debit cards shown.



Card payments are required at the time of Order from non-account Customers. You may also pay by BACS or remit a check to the postal address above.

## FEEDBACK

Escape believes in continuously improving its Goods and services. It can only do this by listening to its Customers. If you have a comment to make please Contact us at the address above or by email at [usafersales@escapefitness.com](mailto:usafersales@escapefitness.com) You may also call the Customer Service Team on 614-706-4462.

# TERMS AND CONDITIONS.

In these Terms and Conditions, Escape Fitness USA LLC is the Supplier and you are the Customer.

## 1. ORDERS.

- 1.1 All orders are subject to these Terms and Conditions ("Conditions") which supersede any terms and conditions you may include with any purchase order regardless of whether Escape sign these or not. We reserve the right to change these Conditions at any time, and you are deemed to accept any changes on the 7th day after the date of any amendment, or the date an order is placed, whichever is the sooner. In the event that products are re-sold, it is your responsibility to ensure that the ultimate purchaser is made aware of and accepts the products on that basis.
- 1.2 Samples, drawings or descriptive or illustrative advertising or other materials contained in brochures or catalogs do not form part of the contract.
- 1.3 Receipt of an electronic, telephonic or other form of purchase order does not signify our acceptance of your order, nor does it constitute confirmation of our offer to sell. We reserve the right, at any time after receipt of your order, to accept or decline your order for any reason, or to supply less than the quantity ordered of any item. Orders are accepted by the issue of an Order Confirmation, normally sent within 48 hours of receipt of your Order, at which time a binding contract will exist between us and the Customer may not amend or cancel the order without our written consent. The Customer is responsible for ensuring that the details set out on the Order Confirmation are complete and accurate.

## 2. PRICE AND PAYMENT.

- 2.1 The price of the products shall be the price set out in the Order Confirmation. Prices are subject to change on not less than 30 days notice.
- 2.2 Payment for the products shall be made in full at the time the order is placed. Sales Tax will automatically be added to orders where liability arises unless Sales Tax Exemption and Re-sale Certificates have been filed. Please note: Sales Tax Exemption and Re-sale Certificates must be filed BEFORE orders are placed to ensure zero rating. We accept payment by company check (allow 10 days for clearance) or wire transfer in U.S. Dollars only. A penalty of \$25 will be charged for any returned payment whatever the reason.
- 2.3 Invoices are issued when the products are shipped.
- 2.4 Credit Account Customers shall pay for products in accordance with their credit account terms and time for payment shall be of the essence of the Contract. Interest is payable on overdue accounts at the rate of 1.5% per month (or such lower rate as may be the maximum permitted by law), accruing on a daily basis from the due date until the date of actual payment of the overdue amount.
- 2.5 Credit Account Customers shall pay all amounts due in full, without any deduction or withholding except as required by law and they shall not be entitled to assert any credit, set-off or counter-claim to justify withholding payment of any such amount in whole or in part. We reserve the right to revoke any credit extended in the event that you fail to pay in accordance with your credit account terms save where a good faith dispute (as determined by us) concerning sums due exists. When credit is revoked, products shall be paid for in advance of shipment.

## 3. PRODUCTS AND SERVICES.

- 3.1 Most products are available to ship immediately, however, some products may have lead times. Orders are accepted for products strictly subject to availability and to these Conditions.

- 3.2 Where orders contain multiple products, we will make every effort to ship all products contained in the order at the same time. Products that are unavailable at the time of shipping shall be shipped as they become available unless you advise us to the contrary in writing. You will be charged only for products actually contained in the shipment. You will pay only a single shipping charge as advised in your Order Confirmation which shall be applied to the first invoice issued.
- 3.3 In the interests of better quality and value, we are constantly improving and updating our products. We therefore reserve the right to change the color, design, specification or packaging in respect of any or all of our product range.

## 4. CUSTOMIZED, BESPOKE AND ASSEMBLED PRODUCTS.

- 4.1 In respect of any Order for customized, bespoke or special order Goods (including but not limited to flooring, frames, MARS screen, racks etc), the Customer may not amend or cancel an Order once accepted (including positioning of equipment where installation is involved). It is imperative that all Customer requirements are fully and accurately conveyed to the Supplier prior to acceptance of the Order. The Supplier accepts no liability for costs, expenses, damages and losses (including any direct, indirect or consequential losses) suffered or incurred by the Customer or any sub-contractor, agent or third party employed by the Customer arising out of any delay in delivery or installation of the Goods where such delay is caused by inaccuracies of whatever nature in the Customers Order.
- 4.2 All designs created in respect of any installation are subject to clause 11 below so that the Customer may not use such designs or any designs that the Supplier believes breach the Suppliers Intellectual Property Rights unless a separate contract for the purchase of a license to use the designs is negotiated and entered into. This clause 4.2 shall survive termination of the Contract howsoever determined.
- 4.3 To the extent that any element or component of the Goods (e.g. line markings, bench upholstery) are to be manufactured in accordance with color and/or design specifications supplied by the Customer, the Customer shall indemnify the Supplier against all liabilities, costs, expenses, damages and losses (including any direct, indirect or consequential losses) suffered or incurred by the Supplier in connection with any claim made against the Supplier for actual or alleged infringement of a third party's intellectual property rights arising out of or in connection with the Supplier's use of that component. This clause 4.3 shall survive termination of the Contract howsoever determined.
- 4.4 The Supplier reserves the right to amend the Specification of the Goods if required so to do by the manufacturer or any applicable statutory or regulatory body.
- 4.5 Where Contracts involve installation and the Customers installation area does not comply strictly with the Working conditions Specification ("Specification") detailed in the Program of Works; the installation shall be delayed until such time as the Customer is compliant with the Specification and the Customer shall be liable to the Supplier for all costs and expenses incurred by the delay. If the Customer delays an installation date on less than 14 days notice; the Customer shall similarly be liable to the Supplier for all costs and expenses incurred by the delay. Without prejudice to the generality of this clause; time when appointed contractors are unable to perform the Contract ("Downtime") shall be payable to the Supplier hourly rate per man per day (based on an 8 hour day) plus full reimbursement of all travel, accommodation and other expenses properly incurred in anticipation of performance of the Contract and which cannot otherwise be recouped

from the relevant provider by the Supplier (Wasted Costs).

## 5. DELIVERY.

- 5.1 Delivery lead times vary according to the products ordered. Products ordered from stock will be shipped within 48 hours of the date of the Order Confirmation. Any date quoted for delivery is approximate only, and time of delivery is not of the essence. We shall not be liable for any delay in delivery of the products that is caused by a Force Majeure Event (as defined in clause 5.5 below), or other event beyond our control, nor any failure by you to provide us with adequate delivery instructions, or any other instructions that are relevant to the supply of the products.
- 5.2 Customized, bespoke, special order and assembled products have varying manufacturing lead times which will be notified to you as the estimated delivery date. A firm delivery date will be notified to you once the finished products are physically ready for dispatch.
- 5.3 Delivery is complete once the products arrive at the exterior access point of the delivery address. Your (or your agents) signature recorded on the Delivery Note (or similar device operated by the carrier) shall be conclusive evidence of the quantities shipped and delivered.
- 5.4 It is your responsibility to ensure that appropriate arrangements are in place to:
  - 5.4.1 accept delivery of the products; and
  - 5.4.2 where there are large/heavy products delivered; provide adequate manpower to unload the products and dispose of any transit packaging supplied.
- 5.5 If you (or your agent) fail to accept or take delivery of the products in accordance with clause 5.4 above, then, save where such failure or delay is caused by a Force Majeure Event or by our failure to comply with our obligations under this Contract, then delivery of the products shall be deemed to have been completed at 9.00am on the day after the delivery date notified by us. We shall store such products until actual delivery takes place, and charge you for all related costs and expenses (including insurance) incurred in this respect. A Force Majeure Event means an event beyond the control of a party (or any person acting on its behalf), which by its nature could not have been foreseen by such party (or such person), or, if it could have been foreseen, was unavoidable, and includes, without limitation, Acts of God, storms, floods, riots, fires, sabotage, civil commotion or civil unrest, interference by civil or military authorities, acts of war (declared or undeclared) or armed hostilities or other national or international calamity or one or more acts of terrorism or failure of energy sources.

## 6. TITLE AND RISK.

- 6.1 The risk in the Goods shall pass to the Customer on completion of delivery.
- 6.2 Notwithstanding delivery and the passing of risk pursuant to clause 6.1, property in and title to the Goods shall remain with the Supplier until the Supplier has received payment of:
  - (a) the full price of the Goods that are the subject of the Contract; and
  - (b) the full price of all other goods and services provided by the Supplier to the Customer under any other contract. Payment of the full price shall include, without limitation, the amount of any interest or other sum payable under the terms of this and all other contracts between the Supplier and Customer.
- 6.3 Until title passes, the Customer shall:
  - (a) store the Goods separately from all other goods held by the Customer so that they remain readily identifiable as the Supplier's property;
  - (b) not remove, deface or obscure any identifying mark or

- packaging on or relating to the Goods;
  - (c) keep the Goods insured against all risks for their full retail price on the Supplier's behalf from completion of delivery.
  - (d) maintain the Goods in satisfactory condition and keep them insured against all risks for their full price from the date of delivery; and
  - (e) give the Supplier such information as the Supplier may reasonably require from time to time relating to the Goods and the financial position of the Customer
- 6.4 At any time before title to the Goods passes to the Customer, the Supplier may require the Customer to deliver up all goods in its possession that have not been resold and if the Customer fails to do so promptly, enter any premises of the Customer or of any third party where the Goods are sold in order to recover them.

## 7. CANCELLATIONS, AMENDMENTS AND RETURNS.

- 7.1 Once an Order Confirmation is issued, orders may only be amended or cancelled if:-
  - 7.1.1 the Customer formally notifies the Supplier in writing by email to [usaftersales@escapefitness.com](mailto:usaftersales@escapefitness.com) or Customer Services Department, Escape Fitness LLC., 4434 West Muhlhauer Road, Suite 300, West Chester, OH; and
  - 7.1.2 the notification is received within 14 days of the date of the Order Confirmation; and
  - 7.1.3 no products have been dispatched.
 A fee of 10% of the Order value (net of tax) will be charged to cover administration costs in such cases. The Supplier reserves the right to reduce the above fee, in its sole discretion, when the amendment sought by the Customer is "de minimis" or there are other exceptional circumstances justifying the same.
- 7.2 Where products have already been shipped, and you wish to return some or all of the products; then in respect of products which require no assembly, they may be returned within 14 days after delivery (as recorded by the Carrier) provided you follow the procedure notified by the Customer Service Department who may be contacted on 614 706 4462 or in writing [usaftersales@escapefitness.com](mailto:usaftersales@escapefitness.com) or Customer Services Department, Escape Fitness LLC., 4434 West Muhlhauer Road, Suite 300, West Chester, OH. The products must be returned to us and you must pay the cost of shipping. Returned products must reach us in a new and unused condition with all original labels and packaging intact. A re-stocking fee of 20% of the returned products value (net of tax) will be deducted from the sum to be refunded.
- 7.3 Be-spoke or customized products may not be returned.
- 7.4 Products may only be returned with a "returns reference number" which you can get from our Customer Service Team. No exceptions! Please call 614 706 4462.

## 8. DAMAGES AND DELIVERY DISCREPANCIES.

- 8.1 All deliveries must be checked as soon as received and BEFORE the Delivery Note is signed. When signing for a delivery, you are accepting that the correct number of parcels have been delivered and the products have not been damaged in transit. If there is damage or a discrepancy, you should either refuse the delivery or record the damage or discrepancy on the Delivery Note (or similar device operated by the carrier) and report the claim by telephoning our Customer Services Team within 24 hours of the delivery time. NOTE: the time of delivery is the time recorded on the Delivery Note (or similar device operated by the carrier). It is your responsibility to ensure that the actions above are followed BEFORE SIGNING as mistakes cannot be rectified once the products have been signed for. Reports of damage or discrepancy will not be entertained after the expiration of 24 hours from the time of delivery as recorded on the Delivery Note or similar device

operated by the carrier.

8.2 Any latent damage to the products MUST be notified to us by telephoning our Customer Services Team immediately upon discovery when you will need to supply us with full details of the products ordered and the damage identified. In our sole discretion, we will either replace or repair the products.

#### 9. INTELLECTUAL PROPERTY RIGHTS.

You acknowledge that all intellectual property rights in the products (including actual products as well as product, flooring and gym design), whether registered or unregistered and including all applications for and renewals or extensions of such rights, and all similar or equivalent rights or forms of protection in any part of the world including all patents, rights to inventions, utility models or prototypes, copyright and related rights, trademarks, service marks, trade, business and domain names belong to, or are used by Escape under License or one of its associated companies. You agree not to use the same unless a license has been granted within a contract for the provision of products by us or one of our associated companies.

#### 10. PRODUCT COMPLIANCE.

10.1 All products supplied by us comply with all applicable laws (including patent laws) statutes, rules and regulations of the United States government and any related law, rule or regulation. Whilst we endeavor to ensure that the product images, descriptions, weights and measurements which appear in any of our literature are fair and accurate; the color, packaging and product specification may vary according to manufacturing changes, tolerances and availability. We reserve the right to discontinue or change the specification and/or the design of a product without prior notice N.B. All weight indications are KG dominant and conversions to LB's are therefore approximate. We accept no responsibility for any error or omission to the Customer or at all.

10.2 You agree to use the products delivered herein in accordance with all applicable laws (including without limitation all patent laws), statutes, rules, regulations or orders of the United States government or of any state or political subdivision thereof.

10.3. We agree to indemnify you from (i) any and all judgments and decrees that may be entered against you or your affiliates, arising out of the use or supply of the products, whether it be immediate or remote, and (ii) any and all costs and expenses that you may incur by virtue of our violation of any such laws (including any claims for infringement, whether such infringement be direct or indirect). We agree that we will, at your request and our sole cost and expense, defend or assist in the defense of any suit or action that may be brought against you, your affiliates, immediate or remote, with respect to any violation or infringement.

#### 11. WARRANTIES AND LIMITATION OF LIABILITY.

11.1 We warrant to the original purchaser that the products supplied (deletion) under this Contract shall be free from defects in materials and workmanship and comply with all applicable statutory and regulatory requirements for not less than the warranty period stated on the website in respect of each product and subject to specific product exclusions listed therein.

11.2 We shall not be liable for the products' failure to comply with the warranty in clause 11.1 if:

11.2.1 you make any further use of such products after notifying us of a defect; or

11.2.2 the defect has arisen as a result of your failure to properly store, care for or maintain the products; or

11.2.3 the defect has arisen as a result of us following any drawing, design or specification supplied or specifically requested by you; or

11.2.4 you alter or repair the products without our prior written consent; or

11.2.5 the defect arises as a result of fair wear and tear, corrosion due to perspiration, wilful or negligent damage or the use of the products for a purpose other than the purpose intended or in abnormal use conditions; or

11.2.6 the products differ from their description as a result of changes made to ensure they comply with applicable statutory or regulatory standards.

11.3 Where a warranty claim is made, you are responsible for returning the product to us for inspection (including shipping) following the returns policy outlined in clause 7.4 Once inspected, we will, at our sole discretion, repair or replace the product, issue a credit note or where we find the claim unsubstantiated reject and return the product to you.

11.4 Except as provided in this clause 11, we shall have no liability to you in respect of the products' failure to comply with the warranty set out in clause 11.1 or otherwise. We assume no responsibility for personal injury or property damage by or through the use of products supplied by us.

11.5 THIS WARRANTY IS IN LIEU OF ALL OTHER WARRANTIES, EXPRESSED OR IMPLIED, ARISING BY LAW OR OTHERWISE INCLUDING WARRANTY, MERCHANTABILITY OR FITNESS FOR PURPOSE, AND IS IN LIEU OF ALL OTHER LIABILITIES OF ESCAPE FITNESS USA LLC INCLUDING DIRECT, INDIRECT, SPECIAL AND CONSEQUENTIAL DAMAGES OR PENALTIES EXPRESSED OR IMPLIED WHETHER ARISING OUT OF CONTRACTING, NEGLIGENCE OR TORT.

11.6 Nothing in these Conditions excludes or limits liability for;

(a) death or personal injury caused by the negligence of the Supplier, or

(b) fraudulent misrepresentation or any other liability that the Supplier may not otherwise exclude or limit under applicable law.

11.7 Notwithstanding the above and subject to clause 11.5, the Supplier's aggregate liability (whether in contract, tort or otherwise) for loss or damage shall in any event be limited to a sum equal to the amount paid or payable by the Customer for the Goods in respect of one incident or series of incidents attributable to one cause.

#### 12. GENERAL.

12.1 These Conditions, including the documents referred to herein, supersede all prior representations, understandings, agreements and contracts between us relating to the supply of products and sets forth the entire agreement and understanding between us.

12.2 Nothing in this Contract is intended to, nor shall be deemed to, constitute a partnership or joint venture of any kind, nor constitute any party the agent of another party for any purpose. No party shall have authority to act as agent for, or to bind, the other party in any way.

12.3 A person who is not a party to the Contract shall not have any rights under or in connection with it.

12.4 You may not assign or sub-contract any of the rights or obligations imposed by this Contract unless agreed to in writing by us.

12.5 We reserve the right to transfer, assign, novate or sub-contract the benefit of the whole or part of any of its rights or obligations under these Conditions or any related contract to any third party.

12.6 No delay or failure by us to exercise any powers, rights or remedies under this Contract will operate as a waiver of them nor will any single or partial exercise of any such powers, rights or remedies preclude any other or any further exercise of them. To take effect any waiver must be in writing and signed by one of our authorized signatories.

12.7 This Contract, and any dispute or claim arising out of or in connection with it or its subject matter or formation (including non-contractual disputes or claims), shall be governed by, and construed in accordance with the laws of the State of Ohio, and the parties irrevocably submit to the exclusive jurisdiction of the Ohio District Courts.

# GENERAL WARRANTY INFORMATION.

All Escape products are warranted to be free from defects in materials and workmanship. This warranty extends to the original end-user and additionally warrants that the products comply with all applicable statutory and regulatory requirements. The warranty period commences on the date of delivery to the end-user (as recorded by the carrier) provided always that this date is not more than 3 calendar months from the date of dispatch from Escape. Subject to the Exclusions section herein, the warranty is valid for not less than the period stated in the schedule below.

#### EXCLUSIONS.

Escape shall have no liability under the warranty if:

- any further use of the product(s) is made after a defect has been notified; or
- the defect has arisen as a result of a failure to properly store, care for or maintain the products; or
- the defect has arisen as a result of Escape following any drawing, design or specification supplied or specifically requested by you; or
- the product(s) is altered or repaired without our prior written consent; or
- the defect arises as a result of fair wear and tear, corrosion due to perspiration, wilful or negligent damage or the use of the products for a purpose other than the purpose intended or in abnormal use conditions; or
- the products differ from their description as a result of changes made to ensure they comply with applicable statutory or regulatory standards.

#### MAKING A CLAIM.

To make a warranty claim, you should follow the claims procedure below. Once determined, Escape will, at its sole discretion, repair or replace the product, issue a credit note or refund, or, where the claim is found to be unsubstantiated, reject (and where appropriate) return the product to you.

#### CLAIMS PROCEDURE.

- If you purchased your product through an Escape approved Distributor, contact your Distributor who will deal with your inquiry directly on your behalf.
- If you purchased your product directly from Escape, you will need to either telephone Escape's Customer Services Department on +1 614 706 4462 or email [usaftersales@escapefitness.com](mailto:usaftersales@escapefitness.com) quoting the Order Number of the product which is subject to the claim and provide full details of how and when the product(s) has been used, the fault or damage identified and contact details of the person dealing with the claim. The claim will be logged and given a unique "X" reference which needs to be quoted in all future dealings with the claim.

- You must then send photographic evidence by email or post of the product and the damage/defect after which our quality control department will report their findings and advise whether the claim is accepted or rejected. If accepted, we will advise whether the product will be repaired or replaced, or if a credit or refund will be made and whether or not the product(s) needs to be returned to Escape for quality control investigation.
- If a product(s) needs to be returned to Escape, we will contact you to arrange a mutually convenient time.
- After your claim has been processed we will contact you again to ensure that your claim was satisfactorily solved.

Escape shall not be liable, in contract or tort, (including, without limitation, negligence), for pre-contract or other representations (other than fraudulent misrepresentations) or otherwise arising out of or in connection with a claim for any economic losses (including without limitation loss of profit, revenue, contracts, business or anticipated savings); loss of goodwill or reputation or special or indirect losses suffered or incurred and arising out of or in connection with the provision of the products. Escape's aggregate liability (whether in contract, tort or otherwise) for loss or damage shall in any event be limited to a sum equal to the amount paid or payable for the product(s) in respect of one incident or series of incidents attributable to one cause.

Please refer to [www.escapefitness.com/us/warranties](http://www.escapefitness.com/us/warranties) for full product warranty schedule.

# WE CREATE INSPIRING SPACES THAT DRIVE PEOPLE TO ESCAPE THEIR LIMITS.

Our expert team design gym spaces that have turned dreams into reality on projects across the globe. Their insight, creativity and experience combine for comprehensive solutions that both stand out and stand the test of time. Utilising our innovative fitness equipment we enable our clients to achieve a wide variety of goals.



SCAN HERE TO VIEW OUR CASE STUDY VIDEOS AND LIBRARIES.

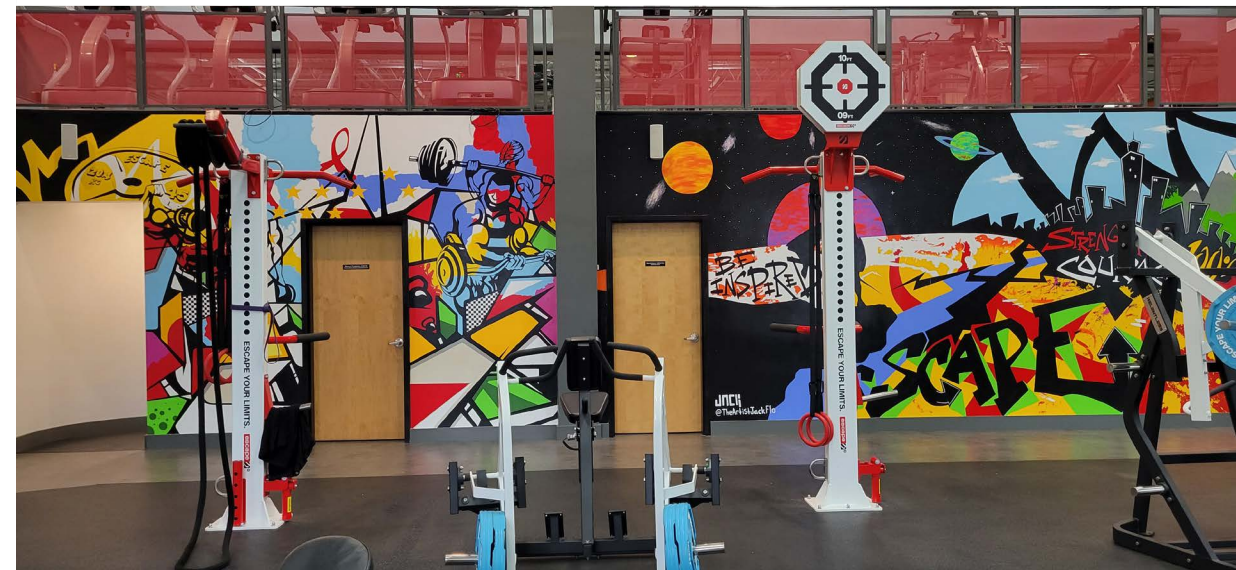
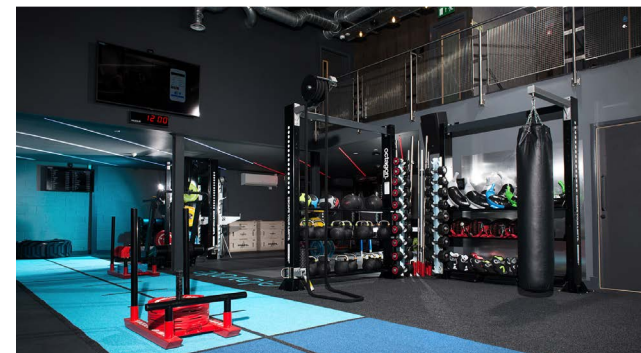



# ESCAPE YOUR LIMITS.

## **ESCAPE FITNESS USA LLC.**

4434 Muhlhauser Road, Suite 300,  
Westchester, OH 45011, USA

**TELEPHONE** +1 614 706 4462

**EMAIL** salesusa@escapefitness.com

**WEBSITE** www.escapefitness.com/us

Registered in USA 201206600158

## **ESCAPE FITNESS LTD HEAD OFFICE.**

11-14 Tresham Road, Orton Southgate,  
Peterborough, Cambridgeshire,  
PE2 6SG, England

**TELEPHONE** +44 1733 313 535

**FACSIMILE** +44 1733 316 539

**EMAIL** sales@escapefitness.com

**WEBSITE** www.escapefitness.com

Registered in England 4215703

## **ESCAPE FITNESS POLAND SP. Z O.O.**

**TELEPHONE** +48 59 863 43 22

**EMAIL** poland@escapefitness.com

**WEBSITE** www.escapefitness.com/pl

Registered in Poland 0000244786

© **ESCAPE FITNESS LIMITED 2023.**